



EchoNous

User Manual

EchoNous Bladder

EchoNous Vein

INTENTIONALLY LEFT BLANK

Contents

CHAPTER 1	Important Information	1
	About the user guide	1
	<i>Manual conventions</i>	1
	<i>Symbols in this user guide</i>	2
	<i>Warnings, cautions and contraindications</i>	2
	<i>Version information</i>	2
	Product description	2
	Intended uses	3
	<i>Contraindications</i>	3
	System and transducer applications	4
	Training	7
	Package contents	7
	System features	8
	Classifications	8
	Patient environment	9
	Cautions, warnings, and contraindications	9
	<i>Warnings</i>	10
	<i>Cautions</i>	12
	<i>Contraindications</i>	13
	Labeling	14
	Contact information	19
	<i>United States</i>	19
	<i>Australia</i>	20
	Trademarks and document copyright	20
CHAPTER 2	Getting Started	23
	Unpacking the boxes	23
	<i>Options</i>	23
	Connecting and disconnecting the power supply	23
	Setting up the system	24
	Basic device control	24
	<i>System controls</i>	25
	<i>System status icons</i>	25
	<i>System notification icons</i>	26
	<i>Menu</i>	26
	Settings	26
	Network printer setup (optional)	27
	Bluetooth printer setup (optional)	28
	Barcode scanner setup (optional)	29

Imaging screens	29
<i>Bladder volume screens</i>	31
<i>Vascular access screens</i>	32
Recommended ultrasound transmission gel	34
Recommended ultrasound probe sterile sheaths	34

CHAPTER 3 **Scanning 35**

Preparing for the exam	35
Default settings	35
Bladder scanning	36
<i>Measuring bladder volume</i>	36
<i>Bladder Measurement Correction</i>	39
<i>Audio feedback</i>	39
<i>Tips for obtaining bladder volume</i>	40
<i>Phantom mode</i>	42
Abdominal Ultrasound imaging	42
<i>Ultrasound presets</i>	43
<i>Ultrasound scanning</i>	43
<i>Ultrasound measurement</i>	44
<i>Ultrasound imaging movies</i>	46
Vascular access	46
<i>Vascular access scanning</i>	47
<i>Enabling depths of 4 and 5 CM</i>	48
<i>Vascular access measurement</i>	48
<i>Vascular access movies</i>	49
Common functions	50
<i>Multiple scans</i>	50
<i>Deleting images</i>	50
<i>Ending/saving exams</i>	50
After use	50
Turning the system off	50

CHAPTER 4 **Other Functions 51**

Annotations	51
<i>Text annotations</i>	52
<i>Voice annotations</i>	52
Exam notes	53
Entering patient details	53
Printing	54
Export	55
Scan review	55
Deleting exams and patients	56
Data security	57
<i>Setting a device password</i>	57

CHAPTER 5 Maintenance and Troubleshooting **59**

- Maintenance **59**
- Battery maintenance **60**
- Probe cleaning and disinfection **61**
 - Cleaning* **62**
 - Disinfection* **62**
- Troubleshooting **65**
 - Clinical troubleshooting* **65**
 - EchoNous customer support* **66**

CHAPTER 6 Connectivity and Accessories **67**

- Accessories **67**
- System connectivity **68**
 - Power sources* **68**
 - Internal battery* **68**
 - Power supplies (chargers)* **69**
 - EchoNous stand setup* **69**
 - EchoNous AI Station power management* **72**
 - EchoNous AI Station troubleshooting* **73**
 - Cleaning* **73**
 - Disinfection* **73**

CHAPTER 7 Specifications **75**

- System dimensions **75**
- Environmental operating and storage conditions **76**
 - Mode of Operation* **76**
- Power supplies (chargers) **76**
- Internal battery **76**
- Measurement accuracy **77**
- Degree of protection against ingress of water **78**

CHAPTER 8 Safety **81**

- Ergonomics **81**
- External materials **81**
- Disposal **81**
- Electrical safety **82**
- Electromagnetic compatibility (EMC) **83**
- Power supplies (chargers) **87**
- Biological safety **87**

Acoustic output **87**

CHAPTER 9 **Advanced device and IT setup 89**

Administrator setup **89**

Software updates restrictions **89**

User management **89**

Multiple device setup **91**

Imaging restrictions **91**

Data recording restrictions **92**

Storage access restrictions **92**

CHAPTER 10 **References 93**

Glossary **94**

CHAPTER 1 Important Information

About the user guide

This user guide is a reference tool for users of the EchoNous™ System; it does not constitute medical advice nor provide clinical training, instruction in exam protocols, or information on how to interpret scans.



This guide should be read before the System is used. The System is intended to be used in a medical facility.

Manual conventions

The following style conventions are used in this manual:

- Buttons found on your EchoNous System are indicated in bold italics, such as ***Scan button***. This style is also used to describe areas of the display touch screen, such as ***Image name***.
- “Tap” refers to touching the screen quickly with your finger.
- “Click” refers to pressing and releasing the button on the probe unit.
- “Drag” refers to touching the screen with your finger and then moving your finger across the screen.
- “Swipe” refers to moving your finger across the screen quickly.
- “Pinch” refers to moving two fingers in a pinch motion or pinch release motion across the screen.
- “Check” refers to tapping a check box to enable the associated function.
- “Uncheck” refers to tapping a check box to disable the associated function.
- “Select” refers to tapping a menu item from a menu list.
- New terms that describe functions are introduced in italics, such as *exam*.
- Numbered steps must be performed in a specific order.
- Bulleted items are lists in no specific order.
- Links to other sections within the manual appear colored and underlined, such as see [Contact information](#).

Symbols in this user guide

	Warning	A warning describes precautions to prevent injury or loss of life.
	Caution	A caution describes precautions to prevent damage to the device.
	Note	A note provides supplemental information.

Warnings, cautions and contraindications

- Warnings, cautions and contraindications are included throughout this manual along with the content to which they apply. In addition all warnings and cautions are listed in the [“Cautions, warnings, and contraindications” on page 9](#).
- A contraindication is a specific situation in which the device should not be used because it may be harmful to the patient.

Version information

This user guide applies to the EchoNous System with software version V5.0

Product description

The **EchoNous System** consists of a display running **EchoNous System** software, connected to one or two ultrasound probes (EchoNous Bladder™ probe and/or EchoNous Vein™ probe) via cables. The System provides portable ultrasound imaging in either handheld or AI Station scenarios. The System with its two probes has been designed to support the following clinical applications:

- Noninvasive urological imaging
- General ultrasound imaging
- Vascular access procedures

The **System** generates and transmits ultrasound energy in the form of pulses in the 2 to 6 MHz range for the EchoNous Bladder probes and in the 6 to 14 MHz range for the EchoNous Vein probe into a patient, detects the reflected pulses, and processes the information to generate ultrasound images and measure anatomical structures.

The **EchoNous System** display is an off-the-shelf Android tablet approved, pre-configured, and supplied by EchoNous. The display comes with a power supply. When the display is connected to an ultrasound probe, the combination is configured as a medical electrical System.

When equipped with the EchoNous Bladder probe, the **System** enables the user to automatically measure bladder volume with or without a brightness mode (B-mode) image for guidance ([FIGURE 1. System user interface and display](#)). The **System** processes data in real-time, and when the user is not scanning in the correct location to detect a bladder, the display guides the user to the correct location, reducing measurement errors.

The user can elect to scan organs beside the bladder, including the kidney and prostate, with controls to change brightness and depth in this mode.

Intended uses

The **System** enables the user to perform Vascular Access procedures when connected to an EchoNous Vein probe.

Images are able to be annotated by using voice or text. Examination notes can be entered.

The **System** provides optional wireless connectivity allowing remote storage and device tracking.

Accessories for wireless printing, barcode scanning, and the EchoNous AI Station are supported and available in some countries.

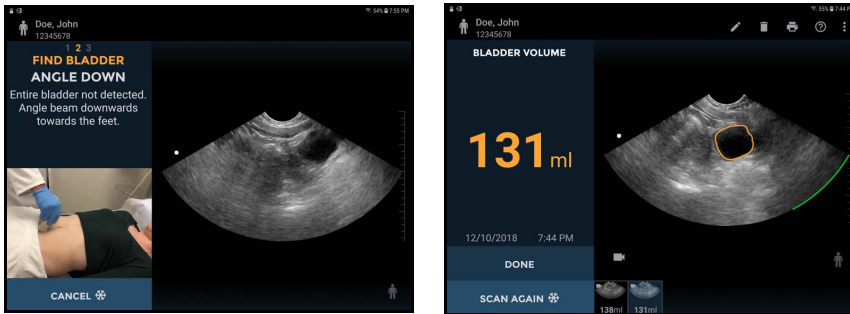

FIGURE 1. System user interface and display



Intended uses

The **EchoNous System** is for noninvasive imaging of the human body and is intended for the following applications: Abdominal, Musculoskeletal, Pediatric, Small Organ, and Peripheral vessel. Users must have ultrasound training for abdominal, musculoskeletal, pediatric, small organ, and peripheral vessel imaging.

The **System** can also be used to obtain an image of the bladder that is used to automatically determine bladder volume.

Contraindications

- The **System** is designed for transcutaneous scanning only. Do not attempt intracavitary imaging; in particular, trans-esophageal, trans-vaginal and trans-rectal scans are contraindicated.
- The **System** is not intended for ophthalmic use or any use causing the acoustic beam to pass through the eye.

	<ul style="list-style-type: none">• Show care when scanning near a wound to avoid damaging or further injuring the affected area.• Review the ultrasound image when measuring bladder volume on pregnant or postpartum patients, and adjust the bladder outline if it has included amniotic fluid or the uterus in the measurement.
	Federal (USA) law restricts this device to sale by or on the order of a physician.

System and transducer applications

TABLE 1. EchoNous System applications

Clinical Application		Mode of Operation	
General	Specific	B-mode	B-mode/ THI
Ophthalmic	Ophthalmic		
Fetal imaging & other	Fetal		
	Abdominal	✓	
	Intra-operative (specify)		
	Intra-operative (neuro)		
	Laparoscopic		
	Pediatric	✓	✓
	Small organ (specify)*	✓	
	Neonatal cephalic		
	Adult cephalic		
	Trans-rectal		
	Trans-vaginal		
	Trans-urethral		
	Trans-oesophageal (non-cardiac)		
	Musculoskeletal (conventional)	✓	
	Musculoskeletal (superficial)		
	Intravascular		
	Other (specify)		
Cardiac	Cardiac adult		
	Cardiac pediatric		
	Intravascular (cardiac)		
	Trans-esophageal (cardiac)		
	Intra-cardiac		
	Other (specify)		
Peripheral vessel	Peripheral vessel	✓	✓
	Other (specify)		

* Small organ use is prostate

TABLE 2. EchoNouS Bladder applications

Clinical Application		Mode of Operation	
General	Specific	B-mode	B-mode/ THI
Ophthalmic	Ophthalmic		
Fetal imaging & other	Fetal		
	Abdominal	✓	
	Intra-operative (specify)		
	Intra-operative (neuro)		
	Laparoscopic		
	Pediatric	✓	
	Small organ (specify)*	✓	
	Neonatal cephalic		
	Adult cephalic		
	Trans-rectal		
	Trans-vaginal		
	Trans-urethral		
	Trans-esophageal (non-cardiac)		
	Musculoskeletal (conventional)	✓	
	Musculoskeletal (superficial)		
	Intravascular		
	Other (specify)		
Cardiac	Cardiac adult		
	Cardiac pediatric		
	Intravascular (cardiac)		
	Trans-esophageal (cardiac)		
	Intra-cardiac		
	Other (specify)		
Peripheral vessel	Peripheral vessel		
	Other (specify)		

* Small organ use is prostate

TABLE 3. EchoNouS Vein applications

Clinical Application		Mode of Operation	
General	Specific	B-mode	B-mode/ THI
Ophthalmic	Ophthalmic		
Fetal imaging & other	Fetal		
	Abdominal		
	Intra-operative (specify)		
	Intra-operative (neuro)		
	Laparoscopic		
	Pediatric	✓	✓
	Small organ (specify)*		
	Neonatal cephalic		
	Adult cephalic		
	Trans-rectal		
	Trans-vaginal		
	Trans-urethral		
	Trans-esophageal (non-cardiac)		
	Musculoskeletal (conventional)		
	Musculoskeletal (superficial)		
	Intravascular		
	Other (specify)		
Cardiac	Cardiac adult		
	Cardiac pediatric		
	Intravascular (cardiac)		
	Trans-esophageal (cardiac)		
	Intra-cardiac		
	Other (specify)		
Peripheral vessel	Peripheral vessel	✓	✓
	Other (specify)		

Training

The **EchoNous System** is intended to be used by clinicians with appropriate professional qualifications and clinical training.

All users should read the generic ALARA education program supplied with your **EchoNous System** (see enclosed ISBN 1-93004 7-71-1, *Medical Ultrasound Safety*) or the Health Canada “Guidelines for the Safe Use of Diagnostic Ultrasound” available on the Health Canada website. This program outlines the guiding principle for diagnostic ultrasound, where the qualified user keeps ultrasound exposure to “as low as reasonably achievable” while performing a diagnostic examination.

In addition to the above, users intending to use the ultrasound imaging function must have appropriate training in ultrasound. Appropriate information on training may be obtained by contacting [EchoNous](#) or your local professional body.

For users measuring bladder volume, an understanding of anatomy and location of the bladder is required. Ultrasound training is required if bladder outline adjustments are to be performed.

Users performing vascular access procedures must have appropriate training in ultrasound guided vascular access. Appropriate information on training may be obtained by contacting [EchoNous](#) or your local professional body.



- You must have appropriate ultrasound training before using the System for general ultrasound imaging or adjusting bladder measurement outlines.
- You must have ultrasound guided vascular access training before using the System for vascular access procedures.

Package contents

The **EchoNous Bladder™ carton** contains the following:

- An EchoNous Bladder probe
- Three Quick Reference Guides: P005601, P005602, and P005613
- A USB Flash device containing:
 - The *EchoNous Bladder and Vein User Guide*
 - Training materials including:
 - A generic ALARA education program (see enclosed ISBN 1-93004 7-71-1, *Medical Ultrasound Safety*)
 - Terms and conditions of Warranty
 - Quick Reference and Setup Guides

The **EchoNous Vein™ carton** contains the following:

- An EchoNous Vein probe with electronics box
- Quick Reference Guide

Important Information

- A USB Flash device containing:
 - EchoNous Bladder and Vein User Guide
 - Training materials including a generic ALARA education program (see enclosed ISBN 1-93004 7-71-1, *Medical Ultrasound Safety*)
 - Terms and conditions of Warranty
 - Quick Reference and Setup Guides

The **EchoNous Display carton** contains the following:

- A tablet (or hand-held display) preconfigured with the **EchoNous System** software
- A Setup Guide

System features

The front of the **EchoNous** Samsung tablet display and probes are shown below.

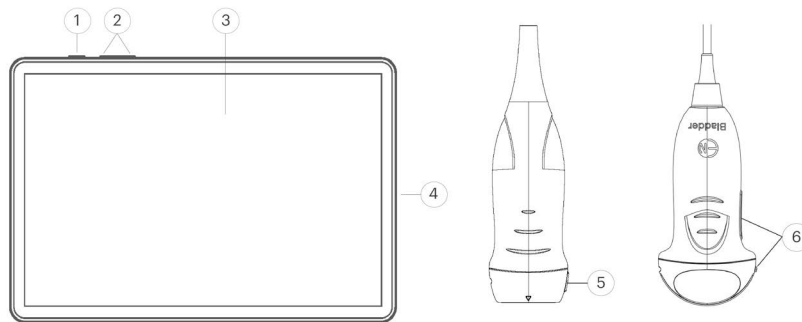

FIGURE 2. System features

TABLE 4. System features

1	Power on/off	4	USB port
2	Volume up/down	5	EchoNous Vein probe orientation marker
3	Touch screen	6	EchoNous Bladder probe orientation marker

The camera for barcode scanning is on the rear of the display.

Classifications

- The **System** is internally battery powered during scanning.
- The EchoNous Type C Power Supply P005179 classification for **Protection against electric shock: Class II equipment**.

- The EchoNous Bladder probe is **Type BF Applied Part**.
- The EchoNous Vein probe (P005134) is **Type BF Applied Part**.
- The EchoNous Bladder probe is classified as **IPX4**.
- The EchoNous Vein probe is classified as **IPX4**.
- The **EchoNous System** is not for use within an oxygen-rich environment.

Patient environment

The **System** is intended to be used in a medical facility. It is battery powered, and the user is expected to bring the System into the patient environment for use. Power supply connections for recharging are to remain outside the patient environment. See [FIGURE 3. Patient environment](#) for a drawing of the patient environment. When a power supply is connected, ensure the connection can be easily disconnected.

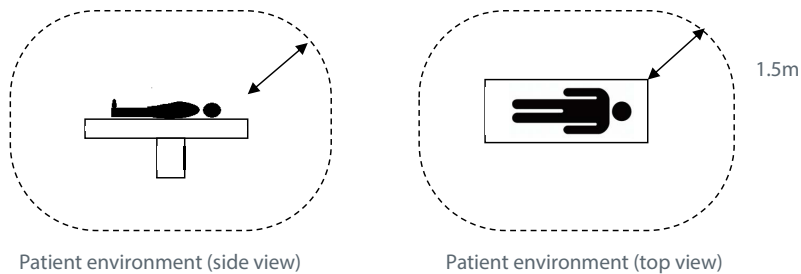

FIGURE 3. Patient environment

	<ul style="list-style-type: none">• Equipment not suitable for use in the presence of a FLAMMABLE ANAESTHETIC MIXTURE WITH AIR OR WITH OXYGEN OR NITROUS OXIDE.• Do not use the System near high-frequency surgical equipment, as it could create a burn hazard.• Do not recharge the System in the patient environment.
--	-------------------------------------------------------------------------------------------------------------------------------------------------------------------------------------------------------------------------------------------------------------------------------------------------------------------------------------------------------------------------------

If fluid is spilled on the probe cable or display, immediately remove the fluid with a soft dry cloth. Carefully inspect the probe cable, USB connector, and display connectors for signs of fluid ingress. If there are any signs of fluid ingress or if the device exhibits any unusual behavior, do not use, and contact [EchoNous](#) customer support or your EchoNous distributor immediately. If required, also follow the cleaning and disinfection instructions (see [Cleaning](#)).

Cautions, warnings, and contraindications

To ensure the device is not damaged and user and patient safety is maintained, please read and follow the cautions and warnings below.

Warnings



- Show care when scanning near a wound to avoid damaging or further injuring the affected area.
- You must have appropriate ultrasound training before using the **System** for general ultrasound imaging or adjusting bladder measurement outlines.
- You must have appropriate ultrasound guided vascular access training before using the **System** for vascular access procedures.
- Review the ultrasound image when measuring bladder volume on pregnant or post-partum patients, and adjust the bladder outline if it has included amniotic fluid or the uterus in the measurement.
- Equipment not suitable for use in the presence of a FLAMMABLE ANAESTHETIC MIXTURE WITH AIR OR WITH OXYGEN OR NITROUS OXIDE.
- Do not use the **System** near high-frequency surgical equipment, as it could create a burn hazard.
- Do not recharge the **System** in the patient environment.
- Recharge the **System** only with the Power Supplies (chargers) provided.
- The **EchoNous** Power Supplies are dedicated units to be used exclusively with the **EchoNous System** only.
- Only connect the Power Supplies to a mains supply rated at 100-240V and 50-60Hz.
- Do not use the device or Power Supply if there are signs of damage.
- Be aware of latex allergy. Some commercially available transducer covers contain latex.
- Check the connecting cable, connectors, and **System** housings before use for cracks or fraying. Do not use if damaged.
- No modification of this equipment is allowed.
- This device contains no user-serviceable parts. Please contact [EchoNous](#) customer support or your EchoNous distributor for maintenance or repair.
- Remove all particles and other matter from crevices and surfaces when cleaning the System and components.
- The device is supplied unsterile.
- Clean and disinfect the patient-applied part between patients.
- Before cleaning or disinfection turn the **System** off and disconnect from the power supply.
- Do not submerge the display or the power supply (charger) as electric shock could result. The EchoNous Vein and EchoNous Bladder probes may be immersed 12mm (1/2 inch) from the cable strain relief for high level disinfection. The remainder of the probe is IPX4 which allows water splashing onto the probe. The display is IPX0 and has no protection against ingress of water.

	<ul style="list-style-type: none">• Clean and disinfect the System before placing in a bag for transport. Use the supplied EchoNous probe holder to store the probe. Clean and disinfect the probe holder regularly.• After cleaning or disinfection examine the ultrasound probe and display as appropriate for cracks or leaks, and if damage exists discontinue use of the System and contact EchoNous customer support or your EchoNous distributor.• The user must not touch any device connectors while in physical contact with the patient.• The ultrasound probes are connected to the EchoNous System display running EchoNous System software to configure a medical System. The display has been certified by EchoNous as part of a medical System to EN IEC 60601-1: Edition 3.1.• Do not connect the EchoNous System display to external computers or peripherals using the USB port unless the System is outside the patient area. Failure to comply with these guidelines may result in electric shock.• Mounting the EchoNous System display on the AI Station or MODO Stand is configuring a medical System. Only use the EchoNous provided AI Station or MODO Stand accessory (P005149 or P004013).• Only connect accessories that are specified as being compatible with the EchoNous System. Contact EchoNous customer support or your EchoNous distributor for information on compatible accessories and Systems.• Do not open or modify the EchoNous Power Supply (P005179) or any other supplied power supplies – Risk of electric shock• Connecting electrical equipment to an (MSO) effectively leads to creating a medical electrical System, and can result in a reduced level of safety.• MSOs (if provided with the medical electrical System) are to be used only for supplying power to the tablet display and optional printer in non-operating mode.• Risk of shock or personal injury when connecting any equipment that has not been supplied as a part of the medical electrical System to the MSO.• An additional MSO or extension cord shall not be connected to the medical electrical System.• MSOs (if provided with the medical electrical System) shall only be used for supplying power to equipment that is intended to form part of the medical electrical System.• Avoid any unnecessary strain on the mains power supply cord.• When adjusting the height of the display unit on the EchoNous AI Station, it is important to safely manage the DC power cord to avoid damage to the cord and risk of electric shock.• Cord wrap must be installed as the lowest component on the AI Station in order to protect the handle bar assembly against falling down into the caster base.
-----------------------------------------------------------------------------------	----------------------------------------------------------------------------------------------------------------------------------------------------------------------------------------------------------------------------------------------------------------------------------------------------------------------------------------------------------------------------------------------------------------------------------------------------------------------------------------------------------------------------------------------------------------------------------------------------------------------------------------------------------------------------------------------------------------------------------------------------------------------------------------------------------------------------------------------------------------------------------------------------------------------------------------------------------------------------------------------------------------------------------------------------------------------------------------------------------------------------------------------------------------------------------------------------------------------------------------------------------------------------------------------------------------------------------------------------------------------------------------------------------------------------------------------------------------------------------------------------------------------------------------------------------------------------------------------------------------------------------------------------------------------------------------------------------------------------------------------------------------------------------------------------------------------------------------------------------------------------------------------------------------------------------------------------------------------------------------------------------------------------------------------------------------------------------------------------------------------------------------------------------------------------------------------------------------------------------------------------------------------------------------------------------------------------------------------------------------------------------------------------------------------------------------------------------------------------------------------------------------------------------------------------------------------------------------------------------------------------------------------------------------------------------------------------------------------------------------------------------------------------------------------------------------------------------------------------------------------------------------------------------------------------------------------------------------------------------

	<ul style="list-style-type: none">• When opening the collar handles for components on the AI Station Mobile Stand, it is important to support the component's weight to avoid damage or injury from falling components.• After storage at extreme temperatures, check the transducer surface temperature before applying to a patient. A cold or hot surface may burn a patient.• Avoid musculoskeletal strain with prolonged use of the System.• Do not incinerate or discard the device in general waste at end of life. The lithium battery is a potential environmental and fire safety hazard.• The EchoNous System complies with the requirements of EN IEC 60601-1 Edition 3.1. To avoid the risk of injury or electrical shock, comply with all safety instruction and warnings.• The EchoNous System complies with the Electromagnetic Compatibility requirements of AS/NZ CISPR 11:2004 and EN IEC 60601-1-2:2014. However, electronic and mobile communications equipment may transmit electromagnetic energy through air and there is no guarantee that interference will not occur in a particular installation or environment. Interference may result in artifacts, distortion, or degradation of the ultrasound image. If the System is found to cause or respond to interference, try re-orienting the System or the affected device, or increasing the separation distance between the devices. Contact EchoNous customer support or your EchoNous distributor for further information• When using the optional mobile stand, the EchoNous System can be susceptible to ESD and may require manual intervention. If ESD results in an error, unplug the probe and plug back in to restore operation.• The ALARA principle (As Low As Reasonably Achievable) should be employed for all medical ultrasound exposure.
-----------------------------------------------------------------------------------	------------------------------------------------------------------------------------------------------------------------------------------------------------------------------------------------------------------------------------------------------------------------------------------------------------------------------------------------------------------------------------------------------------------------------------------------------------------------------------------------------------------------------------------------------------------------------------------------------------------------------------------------------------------------------------------------------------------------------------------------------------------------------------------------------------------------------------------------------------------------------------------------------------------------------------------------------------------------------------------------------------------------------------------------------------------------------------------------------------------------------------------------------------------------------------------------------------------------------------------------------------------------------------------------------------------------------------------------------------------------------------------------------------------------------------------------------------------------------------------------------------------------------------------------------------------------------------------------------------------------------------------------------------------------------------------------------------------------------------------------------------------------------------------------------------------------------------------------------------------------------------------------------------------------------------------------------------------------------

Cautions

	<ul style="list-style-type: none">• Federal (USA) law restricts this device to sale by or on the order of a physician.• Ultrasound transducer crystals are fragile and are easily damaged if knocked, dropped or excessively vibrated.• Avoid unnecessary bending or winding of the connecting cable.• The EchoNous System display batteries should be charged every six months at a minimum, even if you are not using your device. When storing for greater than 3 days, store at ambient or cooler temperature.• Use only recommended disinfection methods.• Use abrasive cleaners, isopropyl alcohol or solvents sparingly, and if used immediately clean and remove residual substances from the System.
-------------------------------------------------------------------------------------	----------------------------------------------------------------------------------------------------------------------------------------------------------------------------------------------------------------------------------------------------------------------------------------------------------------------------------------------------------------------------------------------------------------------------------------------------------------------------------------------------------------------------------------------------------------------------------------------------------------------------------------------------------------------------------------------------------------------------------------------------------------------------------------









- Do not heat sterilize any part of the **System**.
- Minimize application of alcohol based disinfectant to colored overmold materials. Long term use may result in material degradation. If alcohol based disinfectant is applied to the overmold, immediately remove by wiping with a damp cloth.
- Only operate, charge and store the **System** within the approved environmental parameters.
- The **System** contains sensitive components and circuits. Failure to observe proper static control procedures may result in damage to the **System**. Any faults should be reported to [EchoNous](#) customer support or your EchoNous distributor for repair.



Contraindications



- The **System** is designed for transcutaneous scanning only. Do not attempt intra-cavity imaging; in particular, trans-esophageal, trans-vaginal and trans-rectal scans are contraindicated.
- The **System** is not intended for ophthalmic use or any use causing the acoustic beam to pass through the eye.





Labeling

Symbol	EchoNous Description	SDO Title, Ref. No., Standard
	<p>Indicates device manufacturer</p> <p>Includes name and address of the manufacturer</p>	<p>Manufacturer</p> <p>Ref. No. 5.1.1</p> <p>ISO 15223-1</p> <p>Medical devices - Symbols to be used with medical device labels, labeling and information to be supplied - Part 1: General requirements</p>
	<p>UL Classified.</p> <p>Medical - General medical equipment as to electrical shock, fire and mechanical hazards only</p> <p>in accordance with ANSI/AAMI ES 60601-1 (2005) + AMD (2012)/CAN/CSA-C22.2 No. 6060-1 (2008) + (2014).</p> <p>E509516</p> <p>Medical - Refurbished general medical equipment as to electrical shock, fire and mechanical hazards only</p> <p>in accordance with ANSI/AAMI ES 60601-1 (2005) + AMD (2012)/CAN/CSA-C22.2 No. 6060-1 (2008) + (2014).</p> <p>E509516</p>	<p>None</p>
	<p>Tested to comply with FCC standards</p>	<p>None</p>

Symbol	EchoNous Description	SDO Title, Ref. No., Standard
	<p>Class II Equipment</p>	<p>Class II equipment Ref. No. D.1-9 IEC 60601-1 Medical electrical equipment - Part 1: General requirements for basic safety and essential performance</p>
	<p>Type BF applied part (BF = body floating)</p>	<p>Type BF Applied Part Ref. No. D.1-20 IEC 60601-1 Medical electrical equipment - Part 1: General requirements for basic safety and essential performance</p>
	<p>Consult instructions for use for important cautionary information such as warnings and precautions</p>	<p>Caution Ref. No. D.1-10 IEC 60601-1 Medical electrical equipment - Part 1: General requirements for basic safety and essential performance</p>
	<p>Multiple socket outlet is marked with this safety sign and is visible in normal use (used in accordance with IEC 60601-1, Cl. 16.9.2.1)</p>	<p>General warning sign Ref. No. D.2-2 IEC 60601-1 Medical electrical equipment - Part 1: General requirements for basic safety and essential performance</p>

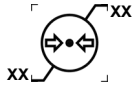
Symbol	EchoNous Description	SDO Title, Ref. No., Standard
	<p>Consult instructions for use</p>	<p>Operating instructions Ref. No. D.1-11 IEC 60601-1 Medical electrical equipment - Part 1: General requirements for basic safety and essential performance</p>
	<p>Do not dispose of this product in normal trash or landfill Refer to local regulations for disposal</p>	<p>Separate collection Annex IX Waste Electrical and Electronic Equipment (WEEE) Directive 2012/19/EU of the European Parliament</p>
<p>IPX1</p>	<p>The probe is protected against effects of vertically falling water</p>	<p>IP Code for degree of protection IEC 60529 Degrees of protection provided by enclosures (IP Code)</p>
<p>IPX4</p>	<p>The probe is protected from splashing water, no matter the direction</p>	<p>IP Code for degree of protection IEC 60529 Degrees of protection provided by enclosures (IP Code)</p>
<p>REF</p>	<p>Part or model number</p>	<p>Catalog number Ref. No. 5.1.6 ISO 15223-1 Medical devices - Symbols to be used with medical device labels, labeling and information to be supplied - Part 1: General requirements</p>

Symbol	EchoNous Description	SDO Title, Ref. No., Standard
<p style="text-align: center;">SN</p>	<p>Serial number</p>	<p>Serial number Ref. No. 5.1.7 ISO 15223-1 Medical devices - Symbols to be used with medical device labels, labeling and information to be supplied - Part 1: General requirements</p>
	<p>Date of manufacture</p>	<p>Date of manufacture Ref. No. 5.1.3 ISO 15223-1 Medical devices - Symbols to be used with medical device labels, labeling and information to be supplied - Part 1: General requirements</p>
	<p>Acceptable temperature range XX is generic placeholder for specified temperatures</p>	<p>Temperature limit Ref. No. 5.3.7 ISO 15223-1 Medical devices - Symbols to be used with medical device labels, labeling and information to be supplied - Part 1: General requirements</p>
	<p>Acceptable humidity range XX is generic placeholder for specified percentages</p>	<p>Humidity limitation Ref. No. 5.3.8 ISO 15223-1 Medical devices - Symbols to be used with medical device labels, labeling and information to be supplied - Part 1: General requirements</p>

Symbol	EchoNous Description	SDO Title, Ref. No., Standard
	<p>Acceptable atmospheric pressure range</p> <p>XX is generic placeholder for specified kPa</p>	<p>Atmospheric pressure limitation</p> <p>Ref. No. 5.3.9</p> <p>ISO 15223-1</p> <p>Medical devices - Symbols to be used with medical device labels, labeling and information to be supplied - Part 1: General requirements</p>
	<p>Stack box this way up</p>	<p>This way up</p> <p>Ref. No. 13</p> <p>ISO 780</p> <p>Packaging - Distribution packaging - Graphical symbols for handling and storage of packages</p>
	<p>Indicates direct current</p>	<p>Direct current</p> <p>Ref. No. D.1-4</p> <p>IEC 60601-1</p> <p>Medical electrical equipment - Part 1: General requirements for basic safety and essential performance</p>
	<p>Indicates alternating current</p>	<p>Alternating current</p> <p>Ref. No. D.1-1</p> <p>IEC 60601-1</p> <p>Medical electrical equipment - Part 1: General requirements for basic safety and essential performance</p>
	<p>Scan button</p> <p>(cross-references scanning control button on probe to instructions in User Manual)</p>	<p>None</p>

Contact information

Symbol	EchoNous Description	SDO Title, Ref. No., Standard
Rx only	Caution: Federal (USA) law restricts this device to sale by or on the order of a physician or any other practitioner licensed by law of the State in which he practices to use or order the device	FDA Guidance for Industry: Alternative to Certain Prescription Device Labeling Requirements
	Equipment mass including safe working load XXX indicates specified weight (used in accordance with IEC 60601-1, Cl. 7.2.21)	None
UDI		

Contact information

United States

EchoNous Inc.

8310 154th Avenue NE

Building B, Suite 200

Redmond, WA 98052

Technical Support (toll free) (844) 854 0800

Sales (toll free) 1 (844) 854 0800

Email support@EchoNous.com

Website www.EchoNous.com

Australia

Australia Sponsor

LC & Partners Pty Ltd

North Sydney, NSW, 2060

Australia

Tel: +61 2 9959 2400

Trademarks and document copyright

EchoNous, the EchoNous logo, EchoNous Bladder, EchoNous Vein, and EchoNous AI Station are registered and unregistered trademarks of EchoNous, Inc. Unauthorized use is strictly prohibited.

Mopria,[®] the Mopria[®] Logo, and the Mopria[®] Alliance logo are registered trademarks and service marks of Mopria Alliance, Inc. in the United States and other countries. Unauthorized use is strictly prohibited.

All other trademarks are the property of their respective owners.

© EchoNous, Inc., 2020

INTENTIONALLY LEFT BLANK

CHAPTER 2 Getting Started

Unpacking the boxes

Your **EchoNous System** is shipped in multiple boxes. Be careful not to insert anything sharp through the top of the boxes when opening. Check that you have received all of the ordered components:

- An **EchoNous System** display (with preinstalled **EchoNous System** software), associated power supply, and setup guide.
- An **EchoNous Bladder** probe with USB flash drive and quick reference guides.
- An **EchoNous Vein** probe, cable, USB flash drive, and quick reference guide.

Options

- Wireless printer (Citizen Systems Model CMP-20BTU and CMP-20IBTIUC); not available with the EchoNous AI Station. Not for use in patient area
- Wireless barcode scanner (not available in all countries; contact [EchoNous](#) customer support or your EchoNous distributor for recommended scanners)
- MODO Stand (P004013) with EchoNous power supply and probe connection cable
- EchoNous AI Station (P005149) with EchoNous HUB, power supply and necessary cables
- EchoNous AI Station 2 (P006259) with EchoNous HUB, power supply, and necessary cables
- EchoNous Carrying Case (P005900)

If any parts are missing or damaged, contact EchoNous customer support or your EchoNous distributor as soon as possible.

Connecting and disconnecting the power supply

You should fully charge the display before using it for the first time.

- ★ To use it with the stand, connect the display to the HUB, and charge it with the HUB power supply.

- ★ To use it without the stand (hand held), connect the tablet with the tablet power supply.

	<ul style="list-style-type: none">• Recharge the System only with the power supplies (chargers) provided.• The EchoNous power supply is a dedicated unit to be used exclusively with the EchoNous System only.• Only connect the power supplies to a mains supply rated at 100-240V and 50-60Hz.• Do not use the device or power supply if there are signs of damage.
-----------------------------------------------------------------------------------	-------------------------------------------------------------------------------------------------------------------------------------------------------------------------------------------------------------------------------------------------------------------------------------------------------------------------------------------------------------------------------------------------------------------------------------

Setting up the system

To set up the system with an optional EchoNous AI Station, refer to [EchoNous stand setup](#). To configure the **System** for mobile use, follow the instructions below:

1. Press and hold the **Power button** for two seconds to turn the **EchoNous** Display on.
2. The application setup wizard will run. Set up the following:
 - 0.1 Language.
 - 0.2 Date and time
 - 0.3 Wi-Fi connectivity.
 - 0.4 Probe selection.
 - 0.5 Registration information.

After setup, the Home screen is displayed, and the device is ready to use with the default settings. The default settings are appropriate where there is a single user of the **System** and patient data is not saved to remote servers. The **System** can be further customized by setting preferences (see [Settings](#)).

Basic device control

The **System** communicates with the user in a number of ways:

- Menus
- Screens and windows
- Message boxes
- Icons

Navigate by using the touch screen with common control gestures, such as tap, drag, pinch, spread, and swipe.

The system controls and status are shown in [FIGURE 4. Home screen](#).

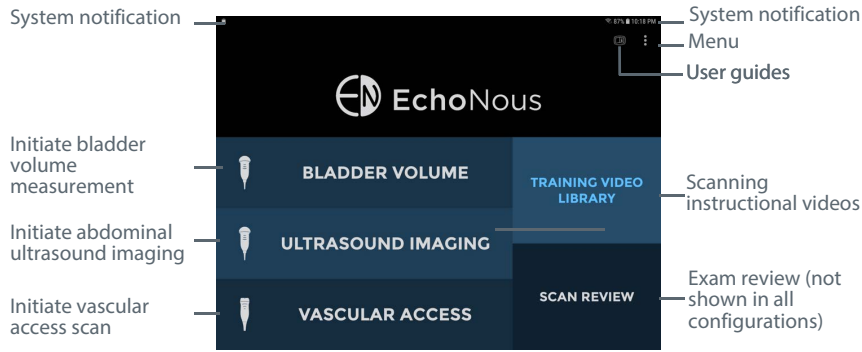

FIGURE 4. Home screen

System controls

For the S3 tablet, three system controls are always available at the bottom of the screen:

< **Back** – tap to return to a previous screen.

□ **Home** – tap to return to the **Home screen**.

☰ **Tasks** – tap to display background tasks (this should not be used except by administrators or service staff).

For the Samsung S6, S7 and S8 tablets, the system control is on the bottom of the screen.

System status icons

System status icons are shown at the top right of the screen:

🔋 Tablet battery status

📶 Wi-Fi status

📶 Bluetooth status (used for wireless printing and barcode scanning)

📍 Location services – The device GPS is active and transmitting.

🌐 Ethernet status

System notification icons

System notification icons are shown at the top left of the screen:

 **EchoNous System** software notification.

 The remote Device Manager has located the device.

Menu

★ Tap  to go to the menu. The following menu items are available:

- **Settings** – provides access to all **EchoNous System** application and tablet system settings.
- **About** – displays the software version number and license keys.

Settings

To set up or change preferences or tablet system settings, tap  from the Home screen and select **Settings**. The following preferences can be configured:

- **Exam Data Storage** – tap to see storage preference.
 - **Local Storage** – check to automatically store patients and images on the tablet internal storage.
 - **Remote Storage** – check to automatically store patients and images to a remote server. For **Remote Server**, select the type of remote server. Some options will only be displayed if the applicable license has been purchased and installed (see [Advanced device and IT setup](#)).
 - **Patient Data** – select the source for patient lists (see [Advanced device and IT setup](#)).
 - **Exam Patient Details** – check to force users to enter patient information before starting a scan.
 - **Send Anonymized Data to EchoNous** – check to send anonymized images to EchoNous to enable future product improvements. Check with your institution’s data policies or legal department before enabling this option.
 - **Send data over metered connection** - check to allow data to be sent when connected to a metered (cellular) connection.
- **Organization** – tap to update registration details, including organization name and address. These details are transferred to EchoNous when a network connection is available.
- **Printing** – select the Printer Type to None, Network Printer (see [Network printer setup \(optional\)](#)) or Bluetooth Mobile Printer (see [Bluetooth printer setup \(optional\)](#)).
- **Display** – tap to see display preferences
 - **Show Organization and Transducer Frequency** – check to display the Organization and transducer center frequency on the ultrasound image.
 - **Ruler** – check to display a cm ruler down the right side of the ultrasound screen.
 - **Hide home screen Ultrasound Imaging button** – check to remove the Ultrasound Imaging button from the home screen.

Network printer setup (optional)

- **Hide home screen Vascular Access button** – check to remove the disabled Vascular Access button from the home screen. If the EchoNous Vein probe was enabled during initial setup, this setting will have no effect.
- **Bladder Volume** – tap to see bladder volume preferences
 - **Default Patient Type** – tap to change the default patient type (Normal, Pediatric, Deep, Pregnant, Phantom, “Use last selected value”, or “Ask each time”).
 - **Strict Probe Positioning Rules** - check to prevent fanning for bladder volume scans unless the bladder or pubic bone is detected.
- **Vascular Access** – tap to see vascular access preferences.
 - For **Default Patient Type**, tap to change the default patient type (Adult, Pediatric, “Use last selected value”, or “Ask each time”).
 - **Enable 4 to 5 CM** - Enable setting if depths of 4 to 5 CM are desired.
- **Administration** – Refer to [Advanced device and IT setup](#) section for advanced user management and setting up several devices with the same preferences.
- **Maintenance** – provides maintenance related functionality including access to software updates.
- **System Settings** – provides access to tablet system settings, including Wi-Fi, Bluetooth, Display settings, Location services, linked accounts for device tracking, Language, and Date & time.

Network printer setup (optional)

Network printing enables the Mopria Print Service. The Mopria Print Service enables printing to Mopria certified multifunction printers from many manufacturers which are on a connected WiFi network (see www.mopria.org).

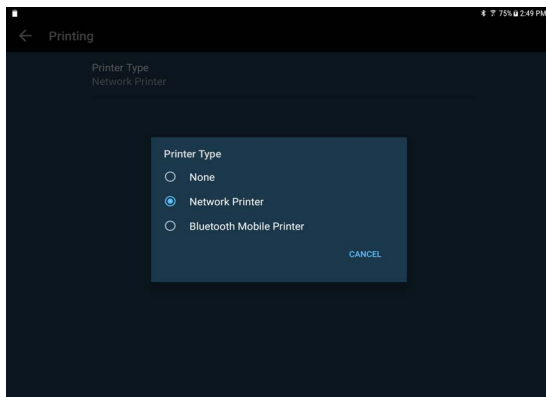



FIGURE 5. Printer type

To set up a network printer:

1. Tap  **Menu**, and select **Settings**.

2. Tap **System Settings** then tap **Connections**.

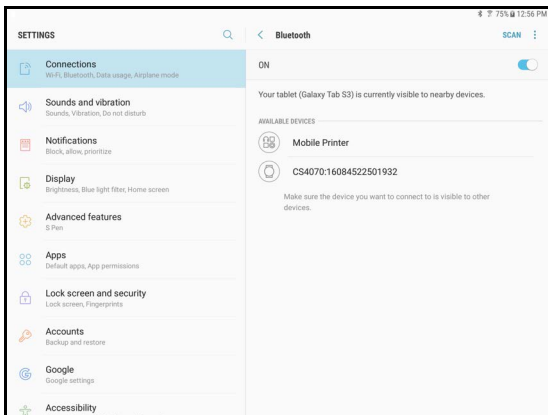









FIGURE 6. Bluetooth Pairing

3. Tap **More connection settings**.
4. Tap **Printing**.
5. Tap **Mopria Print Service**.
6. Slide the on-screen button to the right  to turn **Mopria Printing** on.
7. Tap **Home**  to return to the **Home screen**.
8. Tap  **Menu**, and select **Settings**.
9. Tap **Printing**.
10. Tap **Printer Type**, and select **Network Printing**.
11. Tap **Home**  to return to the **Home Screen**. A printer icon will be shown on all bladder and ultrasound images when Network Printing is selected.

Bluetooth printer setup (optional)

An optional Bluetooth printer is available. Turn the wireless printer on, and then follow the instructions below to set up the printer:

1. From the **Home Screen**, tap  **Menu**, and select **Settings**.
2. Tap **System Settings**, then tap **Bluetooth**.
3. Slide the on-screen button to the right  to turn Bluetooth on.
4. Select **Mobile Printer** to pair it with the system (see Figure 9).
5. Tap **Home**  to return to the **Home Screen**.
6. Tap  **Menu**, and select **Settings**.

Barcode scanner setup (optional)

7. Tap **Printing**.
8. Tap **Printer Type**, and select **Bluetooth Mobile Printer**.
9. Tap **Bluetooth Printer**.
10. Select the paired printer from the list.

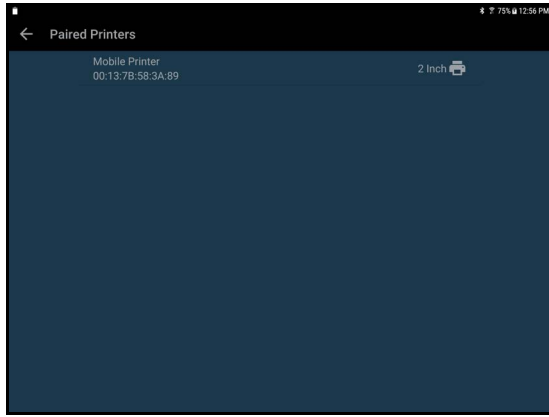





FIGURE 7. Bluetooth printer setup

11. Tap **Home**  to return to the **Home Screen**.

Barcode scanner setup (optional)

An optional wireless barcode scanner is supported in some countries. Barcode scanning using the device camera is also supported. To set up the wireless barcode scanner, turn the bar code scanner on, and follow the instructions below.

1. From the **Home Screen** tap  **Menu**, select **Settings**, and select **System Settings**.
2. Tap **Bluetooth**.
3. Slide the on-screen button to the right  to turn Bluetooth on.
4. Select the bar code scanner to pair it with the system.
5. Tap **Home**  to return to the **Home Screen**.

Imaging screens

Ultrasound imaging screens

- ★ Tap **Ultrasound Imaging** on the **Home Screen** to start an ultrasound exam.

See [FIGURE 8. Ultrasound imaging screens](#) for ultrasound screen layouts.

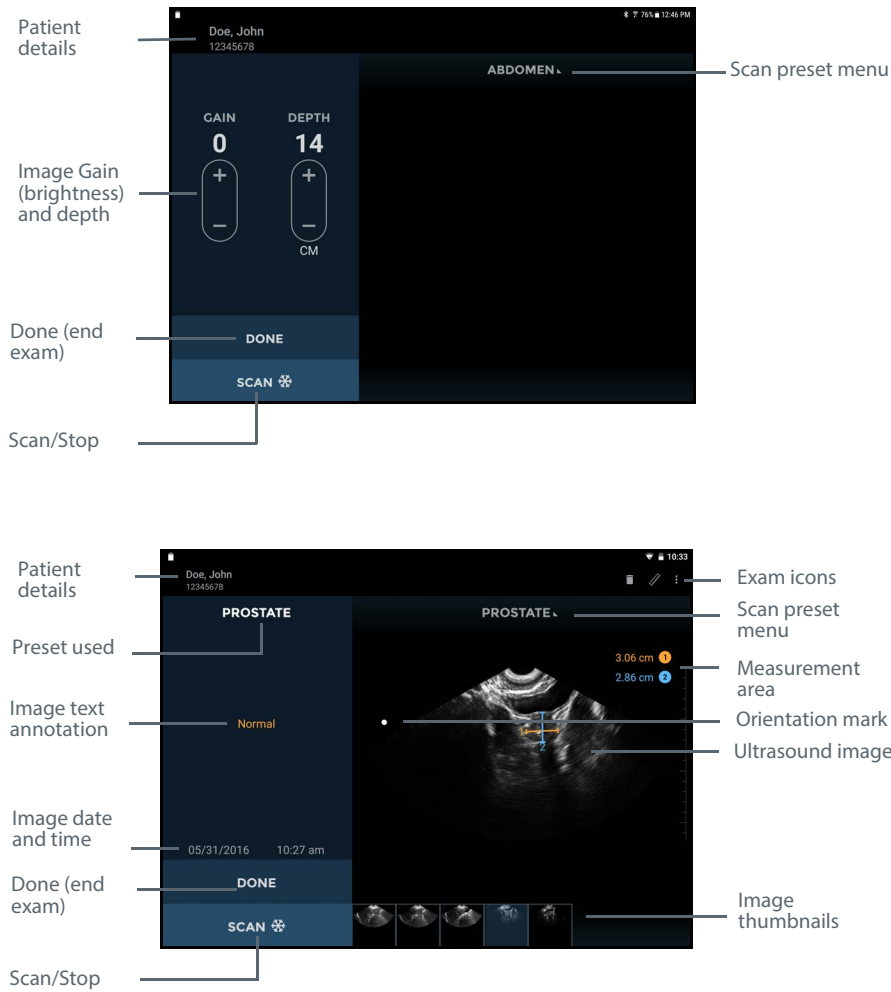

FIGURE 8. Ultrasound imaging screens

The ultrasound imaging screen layouts contain the following areas:

- **Patient Details** – displays patient details for the current exam. Tap to change the patient associated with the exam.
- **Preset Used** – displays the scan preset used for the current image.
- **Image Text Annotation** – displays the text annotation for the image.
- **Image Date and Time** – displays the date and time of the image.
- **Gain and Depth Controls** – adjust the gain (brightness) or the depth for the system.
- **Orientation Mark** – corresponds to the orientation marker on the probe.



Probe orientation marker

- **Done** – tap to end and save the exam.
- **Scan / Stop** – tap to start (unfreeze) and stop (freeze) scans.
- **Exam Icons** – are displayed depending on the context of the exam. Icons include help, print, measure, movie, delete, and a menu to access other functions, such as annotations and notes). Tap to activate the function associated with the icon.
- **Scan Preset Menu** – tap to change to a different scan preset.
- **Measurement Area** – area for displaying caliper and volume measurements.
- **Ultrasound Image** – area for displaying ultrasound images.
- **Image Thumbnails** – will be displayed for multiple images in an exam. Tap a thumbnail to view an image.

Bladder volume screens

- ★ Tap **Bladder Volume** on the **Home screen** to start a bladder measurement.

See [FIGURE 9. Bladder scan screens](#) for bladder screen layouts.



FIGURE 9. Bladder scan screens

The bladder screen layouts contain the following areas:

- **Patient Type** – tap to change the patient type (normal, pediatric, deep, or pregnant).
- **Patient Details** – displays patient details for the current exam.
- **Instructions** – instructions of the current step required for bladder measurement.
- **Instruction Video** – video showing how to perform a bladder measurement.
- **Done** – tap to end and save the exam.
- **Scan/Cancel** – tap to start a bladder volume measurement or to cancel a scan in progress.
- **Scan Again** – tap to start another bladder volume measurement.
- **Orientation Mark** – corresponds to the orientation marker on the probe.



Probe orientation marker

- **Measured Volume** – measured volume in milliliters.
- **Image Text Annotation** – displays the text annotation for the image.
- **Image Date and Time** – displays the date and time of the image.
- **Exam Icons** – are displayed depending on the context of the exam. Tap to activate the function associated with the icon.
- **Ultrasound Image** – area for displaying ultrasound images.
- **Bladder Outline** – indicates the area where the bladder has been detected and outlined.
- **Pubic Bone Indicator** – indicates the area where pubic bone has been detected.
- **Image Thumbnails** – will be displayed for multiple images in an exam. Tap a thumbnail to view an image.

Vascular access screens

- ★ Tap **Vascular Access** on the **Home screen** to start a Vascular Access exam.

See [FIGURE 10. Vascular access screens](#) for vascular access screen layouts.

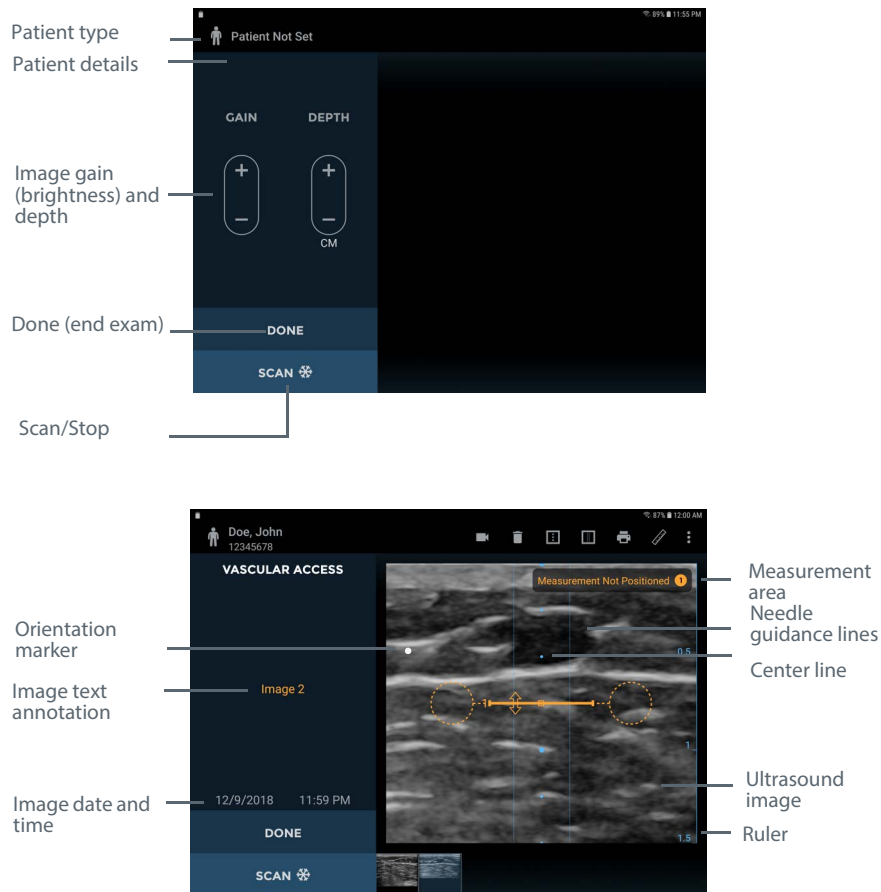





FIGURE 10. Vascular access screens

The vascular access screen layouts contain the following areas:

- **Patient Details** – displays patient details for the current exam.
- **Image Text Annotation** – displays the text annotation for the image.
- **Image Date and Time** – displays the date and time of the image.
- **Gain and Depth Controls** – adjust the gain (brightness) or the depth for the system.
- **Orientation Marker** – corresponds to the probe orientation marker .
- **Done** – tap to end and save the exam.
- **Scan/Stop** – tap to start (unfreeze) and stop (freeze) scans.
- **Exam Icons** – are displayed depending on the context of the exam. Icons include help, print, measure, movie, delete, toggling the center line, toggling the needle guidance lines, and a menu to access other functions, such as annotations and notes. Tap to activate the function associated with the icon.

- **Measurement Area** – area for displaying caliper measurements.
- **Ultrasound Image** – area for displaying ultrasound images.
- **Ruler** – indicates the scan depth in cm.
- **Center Line** – indication of the probe center line. Can be toggled by tapping the  icon.
- **Needle Guidance Lines** – guidance lines for needle insertion. Can be toggled by tapping the  icon.
- **Image Thumbnails** – will be displayed for multiple images in an exam. Tap a thumbnail to view an image.

Recommended ultrasound transmission gel

EchoNous recommends the use of Aquasonic 100 Ultrasound Transmission Gel manufactured by Parker Laboratories, INC. Fairfield, New Jersey 07004.

Recommended ultrasound probe sterile sheaths

Where fluid contamination is possible, cover the ultrasound probe with an appropriate sterile sheath; this promotes asepsis and minimizes cleaning.



Be aware of latex allergy. Some commercially available transducer covers contain latex.

CHAPTER 3 Scanning

Preparing for the exam

	<ul style="list-style-type: none">• Check the connecting cable, connectors, and system housings before use for cracks or fraying. Do not use if damaged.• Do not connect to the Power Supplies and AC outlets when the System is in the patient environment.
-----------------------------------------------------------------------------------	--------------------------------------------------------------------------------------------------------------------------------------------------------------------------------------------------------------------------------------------------------------------------------------------

Before scanning, check you have access to everything you need and the device is ready to scan as follows:

- The **tablet display** is powered on and has battery charge available to scan (the display battery icons shows charge).
- The **ultrasound transducer** has been cleaned or disinfected as appropriate (See [Probe cleaning and disinfection](#)).
- You have suitable ultrasound transmission gel available.
- The patient is positioned appropriately.

Default settings

Press the **Power button** to power up the **System**. Adjustable settings cannot increase acoustic output, ensuring the device always operates within safe acoustic output levels. The **Home screen** appears when the device is on ([FIGURE 15. Home screen](#)), with up to five tiles:

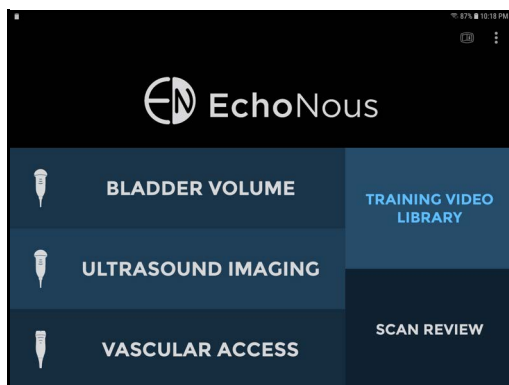

FIGURE 15. Home screen

- Tap **Bladder Volume** to perform a bladder volume examination. This option is only available when connected to a bladder probe.

- Tap **Ultrasound Imaging** to perform a general ultrasound examination. Choose the appropriate **scan preset** from the list. This option is only available when connected to a bladder probe.
- Tap **Vascular Access** to perform a vascular access scan. This option is only available when connected to an EchoNous Vein probe.
- Tap **Training Video Library** to view a series of instructional videos.
- Tap **Scan Review** to review locally stored examinations. This option is not available if **Local Storage** is disabled in [Settings](#).

Bladder scanning

Measuring bladder volume

1. To start a exam, from the **Home screen**, tap **Bladder Volume**.
2. Select the appropriate patient type (Normal, Pediatric, Deep, or Pregnant):
 - **Normal:** BMI less than 30
 - **Deep:** BMI greater than or equal to 30 or scar tissue present
 - **Pediatric:** Weight under 27 kg
 - **Pregnant:** Active pregnancy
3. Lay the patient as flat as can be tolerated.
4. If necessary, palpate the patient’s pubic bone, and place a generous volume of gel just above (about 1 inch or 2.5 cm) the pubic bone
(see [FIGURE 16. Place transducer and start](#)).

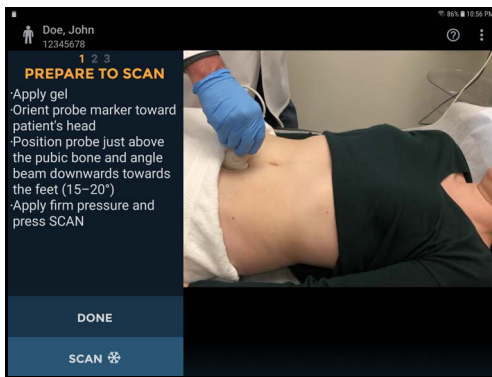

FIGURE 16. Place transducer and start

5. Place the probe just above (about 1 inch or 2.5 cm) the pubic bone with the **probe orientation marker** facing toward the patient's head
(see [FIGURE 17. Probe orientation marker](#)).



FIGURE 17. Probe orientation marker

6. Apply pressure firmly.
7. Tilt the probe 15 to 20 degrees so the probe beam points slightly toward the patient's feet.
8. Tap the **Scan** ✖ button to start the measurement.
 - If the probe is incorrectly positioned, the display will prompt you to angle the probe ([FIGURE 18. Transducer positioning](#)).

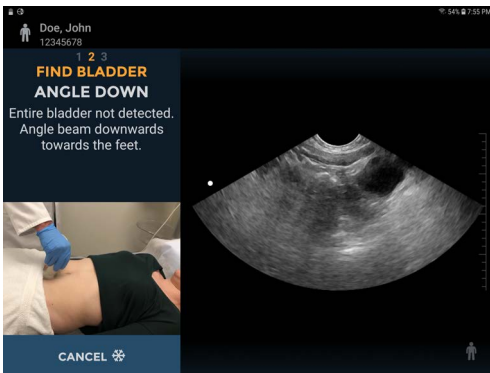

FIGURE 18. Transducer positioning

- When the bladder has been found, an orange outline will appear around the bladder. The pubic bone indicator will appear as a green curved line ([FIGURE 19. Acquire data](#)).

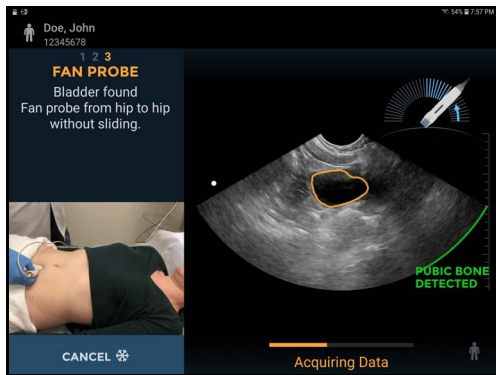

FIGURE 19. Acquire data

9. Maintaining pressure and angle, fan the probe towards one hip until you hear the sound indicator and see an arrow, then fan back towards the other hip until a second sound is heard.
 - When fanning, consider the following:
 - Do not slide the probe.
 - Do not fan too fast or too slow. As a guideline, a complete fan should take around 3-5 seconds.
 - Do not twist the probe.
 - Angle the probe so that the bladder is in the middle of the ultrasound image.
 - During acquisition, the display will show the fan position. When the three dimensional data acquisition is complete, the **System** automatically completes the scan and displays the measured volume (see [FIGURE 20. Measured volume](#)).

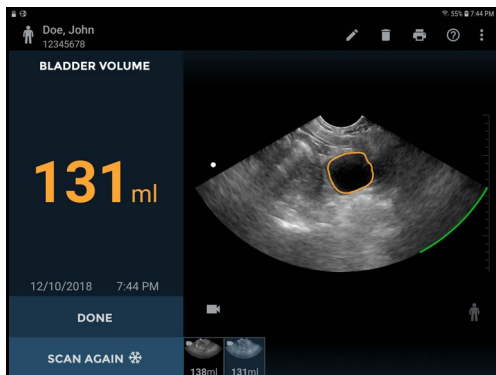



FIGURE 20. Measured volume

A movie of the complete bladder acquisition is displayed.

Bladder Measurement Correction

Correct errors outlining the bladder as follows:

- Tap the **Pencil**  icon to start outline editing.
- Tap the **Pencil Redraw**  icon to delete the existing outline and redraw.
- Touch the **bladder outline** to adjust the existing outline. A drag circle will appear. Drag the outline to align with the bladder wall. The adjusted outlines change color to blue (see [FIGURE 21. Adjusting outline](#)).

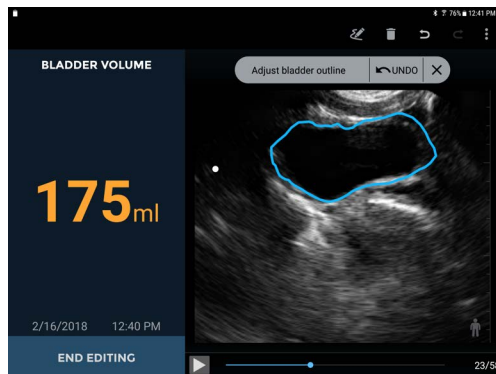





FIGURE 21. Adjusting outline

- For fine adjustments, zoom in to enlarge the image before adjusting the outline.
- Tap the **Play**  button or drag the progress marker  to check other images. Every image in a measurement can be adjusted, if required.
- If a bladder has been outlined where no bladder is present, then drag the progress marker  to the end of the bladder, tap  and select **Mark Bladder End**.
- Tap **End Editing** to finish.

Audio feedback

The **System** provides audio feedback during bladder measurement as follows:

- A short double beep sounds when the **System** has detected a bladder, and you can start the fan of the probe.
- A short single beep sounds when the **System** has detected that more gel is required or that you should move the probe to find the bladder.
- A buzzer sounds if you start fanning the probe before the **System** has found the bladder. You should stop fanning, locate the bladder, and start fanning again when prompted by the **System**.
- A chime sounds when the **System** expects you to change direction of the fan and when the fanning has been completed.
- A beep sounds at the completion of a successful scan.

Tips for obtaining bladder volume

If fanning too fast or too slow:

- Maintain consistent pace and pressure during the scan ([FIGURE 22. Maintain consistent pace](#)).

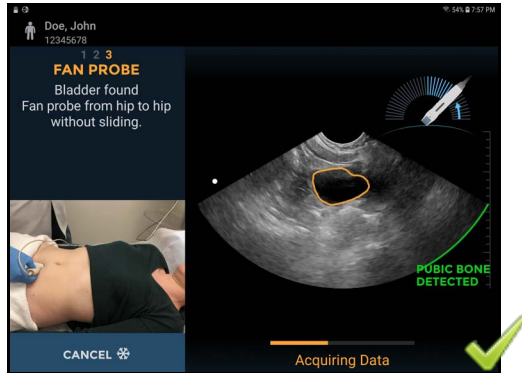

FIGURE 22. Maintain consistent pace

- As a guideline, a complete fan should take around three to five seconds.

If greater than symbol appears along with the volume measurement:

1. Center the bladder in the ultrasound image on the screen.
2. Fan the probe toward one hip until you hear the sound indicator and see an arrow, then fan back toward the other hip until a second sound is heard to capture the entire bladder ([FIGURE 23. Greater than symbol](#)).

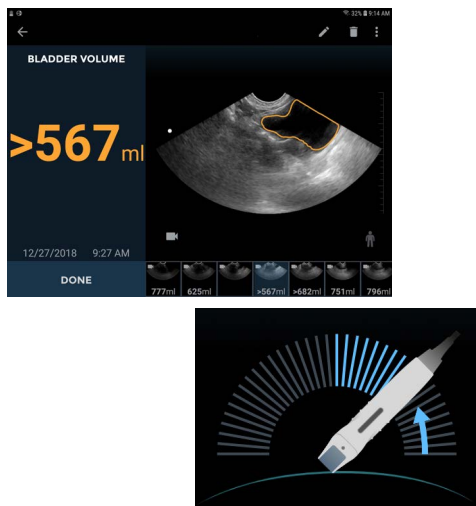

FIGURE 23. Greater than symbol

3. Anchor the pivot point to ensure that the probe does not slide in any direction while fanning.

If twisting is detected:

- Do not rotate the probe during the fanning motion (see [FIGURE 24. Twisting detected](#)).

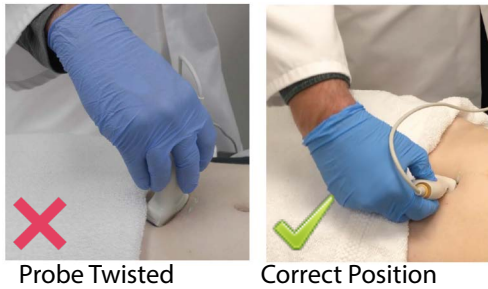

FIGURE 24. Twisting detected

- Make sure that the orientation marker remains pointing toward the patient's head.

If 0 ml reading:

- When obtaining a measurement of 0 ml, tap the <?> icon to display a message indicating possible reasons for an empty result.

- A true low volume bladder scan will present with a clear pubic bone indicator and a clear visualization of a small empty bladder on the screen (see [FIGURE 25. Bladder found/not found](#)).

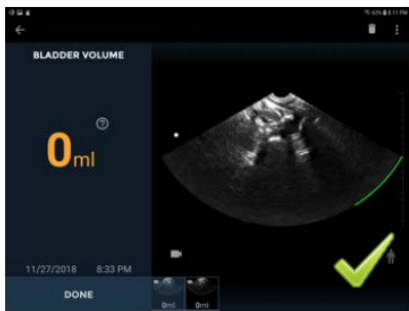

Bladder found

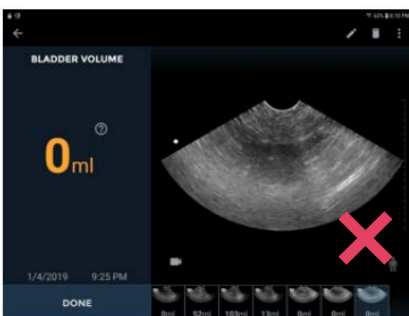

Bladder NOT found

FIGURE 25. Bladder found/not found

Phantom mode

The **System** provides a special patient type for scanning ultrasound phantoms. To select the phantom patient type, tap  and select **Enable Phantom Mode**.

Abdominal Ultrasound imaging

Tap **Ultrasound Imaging** on the **Home screen** (see [FIGURE 15. Home screen](#)) to initiate an ultrasound scan.

Ultrasound presets

Choose the appropriate preset from the **Scan Preset Menu** (see [FIGURE 26. Selecting presets](#)).

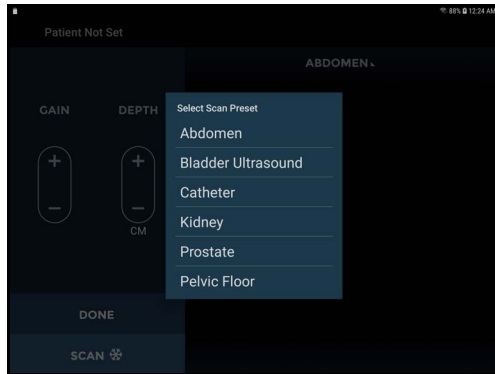

FIGURE 26. Selecting presets

The scan presets are customized ultrasound settings for each clinical application.

Ultrasound scanning

The **probe orientation marker** corresponds to the **Orientation**  icon on the display.



FIGURE 27. Probe orientation markers

The convention is for the **probe orientation marker** to be on the patient's right for transverse scans, and toward the head for sagittal or coronal scans.

- ★ Tap the **Scan**  icon to start (unfreeze) and stop (freeze) ultrasound scans.

Freezing the scan automatically captures an image that is a sector or pie shape of approximately 120° (see [FIGURE 28. Ultrasound scanning](#)). You can save or discard the captured image before closing the exam. See the [Common functions](#) section for more details on multiple scans and ending/saving exams.

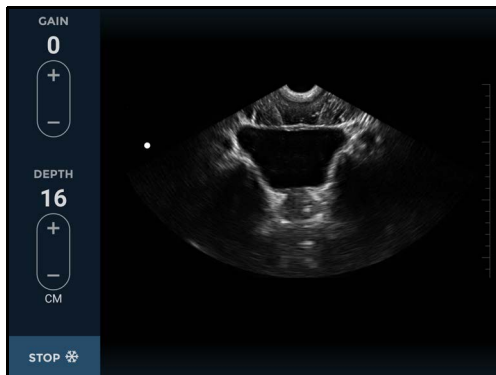



FIGURE 28. Ultrasound scanning

Controls for changing gain (brightness) and depth are provided (see [FIGURE 28. Ultrasound scanning](#)).

Tapping the  icon increases the gain or depth. Tapping the  icon decreases the gain or depth.

Use a two-finger pinch to zoom in or out of images.

Ultrasound measurement

★ Tap the **Measurement**  icon to insert calipers, arrows, or volume measurements on images.

— Calipers measure a straight line distance between two points (see [FIGURE 29. Distance measurement](#)).

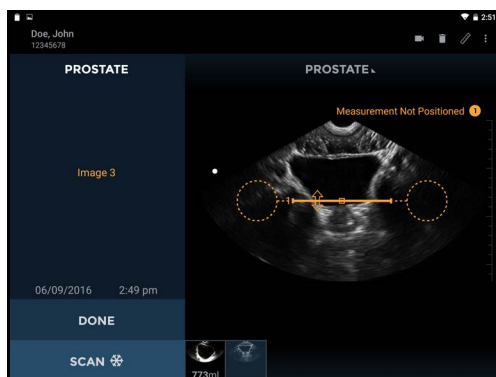

FIGURE 29. Distance measurement

- Arrows highlight part of the image but do not perform a measurement (see [FIGURE 30. Arrow](#)).

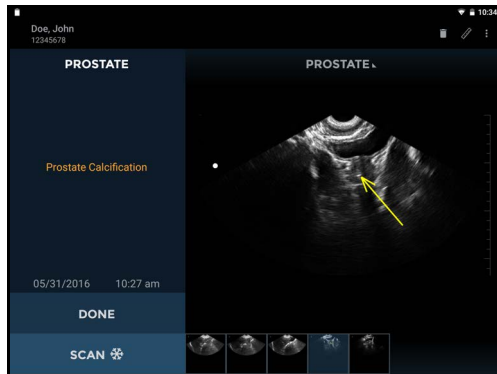

FIGURE 30. Arrow

- Volume Measurements measure an ellipsoid volume using three caliper measurements (longitudinal, transverse, and anteroposterior) across two images (see [FIGURE 31. Resulting volume measurements](#)). The longitudinal and anteroposterior measurements are positioned on the first image, and the transverse measurement is positioned on the second image. The first and second images must be orthogonal.

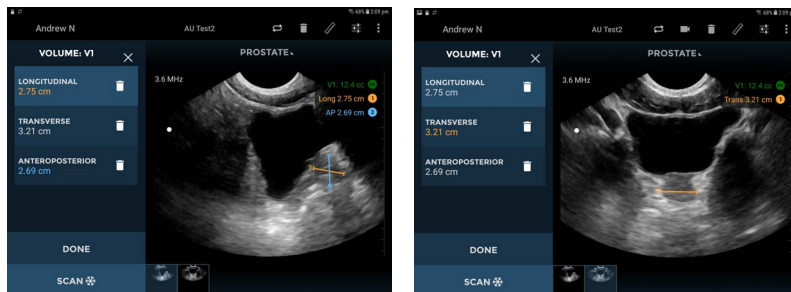





FIGURE 31. Resulting volume measurements

- Move the caliper or arrow using the:

-  Circular handle to position each end of the caliper in the correct place.
-  Square handle in the middle to move the entire caliper around the screen.
-  Double-arrow handle to rotate the caliper around its middle.

- You can insert four measurements per image. Tap the image outside the shape to end editing that shape. Tap a shape to reselect it for editing.
- The units of measurement are cm for distance and cc for volume.

Ultrasound imaging movies

- ★ Tap the **Movie**  icon to save up to 16 seconds of the ultrasound scan as a movie clip (see [FIGURE 32. Saved movie clip](#)).

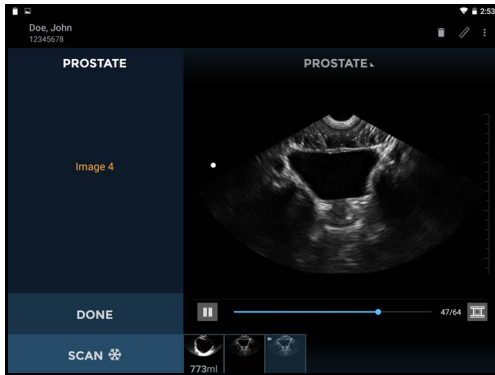





FIGURE 32. Saved movie clip

— The movie clip is saved with a **Movie**  icon in the bottom left of the image area.

— Tap the **Movie**  icon on the image to show the movie controls.



— Scroll through image frames by dragging the progress marker .

— Tap  and  to pause and play the movie clip.



— Tap the **Save Movie**  icon to save the currently displayed image frame.

— Tap anywhere on the image to hide the movie controls.

Vascular access

- ★ Tap **Vascular Access** on the **Home screen** (see [FIGURE 15. Home screen](#)) to initiate a Vascular Access scan.

Vascular access scanning

The probe **Orientation Marker**  corresponds to the orientation marker  on the display. Tap the **Scan**  icon to start (unfreeze) and stop (freeze) ultrasound scans. The image automatically generated is a linear scan that is approximately 25mm wide. (see [FIGURE 33. Vascular scanning](#)).

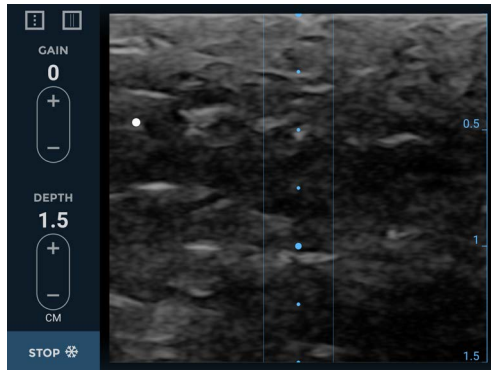





FIGURE 33. Vascular scanning

Controls for changing gain (brightness) and depth are provided (see [FIGURE 33. Vascular scanning](#)).

Tapping the  symbol increases the gain or depth. Tapping the  symbol decreases the gain or depth.

Tapping the  symbol shows and hides the transducer center marker. The probe center marker corresponds to the blue circles on the display.

Tapping the  symbol shows and hides the needle guidance lines.

Use a two-finger pinch to zoom in or out of images.

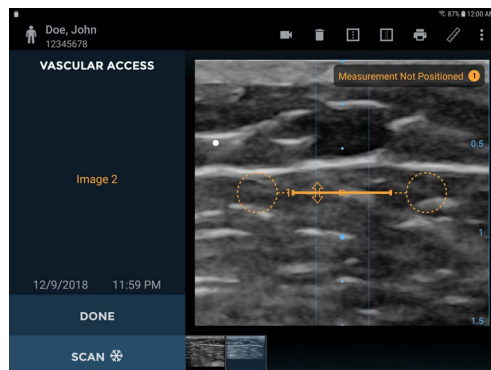



FIGURE 34. Distance Measurement

Enabling depths of 4 and 5 CM

On EchoNous Vein, there are three ways of enabling depths of 4 and 5 CM, if desired.

To enable the setting for all scans:

1. From the home screen, tap the  icon in the upper right corner.
2. Tap **Settings**.
3. Tap **Vascular Access**.
4. Select **Enable 4 and 5 CM depth**.

To enable the setting before a scan and for only the one scan:

1. Tap the  icon in the upper right corner.
2. Select **Enable 4 and 5 CM depth** (see [FIGURE 35. Enable 4 and 5 CM depth](#)).

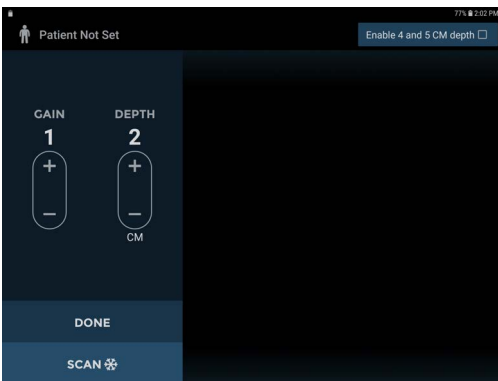





FIGURE 35. Enable 4 and 5 CM depth

3. Tap the **Scan**  icon to start the scan.

To enable the setting during the scan and for only the one scan:

1. Tap the **Stop**  icon to freeze the image.
2. Tap the  icon in the upper right corner.
3. Select **Enable 4 and 5 CM depth**.
4. Tap the **Scan**  icon to continue the scan.

Vascular access measurement

- ★ Tap the **Measurement**  icon to insert calipers, arrows, or volume measurements on images:

Vascular access

- Calipers measure a straight line distance between two points.
- Arrows highlight part of the image, but do not perform a measurement.

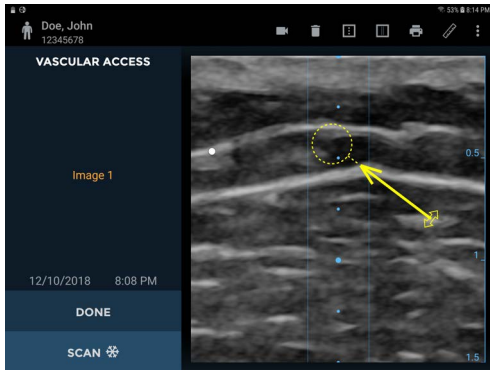





FIGURE 36. Arrow

Move the caliper or arrow using the:

-  Circular handle to position each end of the caliper in the correct place
-  Square handle in the middle to move the entire caliper around the screen
-  Double-arrow handle to rotate the caliper around its middle

You can insert four measurements per image. Tap the image outside the shape to end editing that shape. Tap a shape to reselect it for editing.



The units of measurement are cm.

Vascular access movies

- ★ Tap the **Movie**  icon to save up to 16 seconds of the vascular access scan as a movie clip.

- The movie clip is saved with a **Movie**  icon in the bottom left of the image area.
- Tap the movie icon  on the image to show the movie controls.



- Scroll through image frames by dragging the progress marker .
- Tap  and  to pause and play the movie clip.

Tap the **Save Movie**  icon to save the currently displayed image frame.

Common functions

Multiple scans

1. Tap the **Scan**  icon to add more ultrasound imaging scans or vascular access scans to the exam.
2. To perform additional bladder volume measurements, tap the **Scan Again** icon.
 - Image thumbnails are displayed at the bottom of the image area when multiple scans have been performed. A small movie icon is embedded in movie thumbnails.

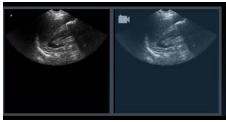

- Tap a thumbnail to view an image or swipe right to left across the image area to move to the next image.

Deleting images

- * Tap the **Delete**  icon to delete the displayed image.

Ending/saving exams

- * Tap **Done** to end the exam. You will be prompted to either:
 - Save all images/movies in the exam,
 - Save selected images/movies in the exam,
 - Discard all images.

A **Remote storage**  icon is displayed next to **Done** when remote storage is enabled. You are prompted to enter patient details (see [Entering patient details](#)) if it is not already entered.

After use

After each use and between each patient, you must clean and properly disinfect the probe and transducer following the steps in this user guide (see [Probe cleaning and disinfection](#)).

Turning the system off

- * Hold down the **Power button** of the **EchoNous System** display to turn the **System** off.

CHAPTER 4 Other Functions

Annotations

Annotations can be added to individual images.

1. Tap the  icon to display the **Exam menu**.
2. Select **Annotation** from the drop-down list box ([FIGURE 37. Annotating](#)).

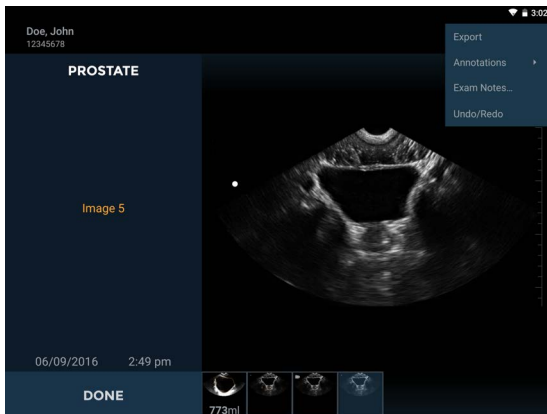

FIGURE 37. Annotating

- 3. Select from the predefined set of annotations, or select text or voice annotation for custom annotations (**FIGURE 38. Annotation list**).

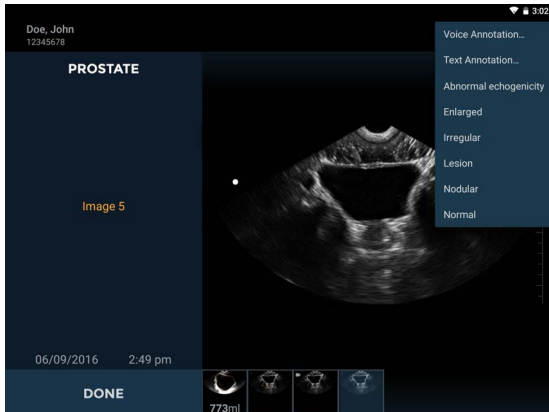

FIGURE 38. Annotation list

Annotations are applied to individual images.

Text annotations

- ★ Select **Text Annotation** to enter custom annotations using the on-screen keyboard.

Voice annotations

- ★ Select **Voice annotation** to save a recorded message with an image. The voice recording controls are displayed.

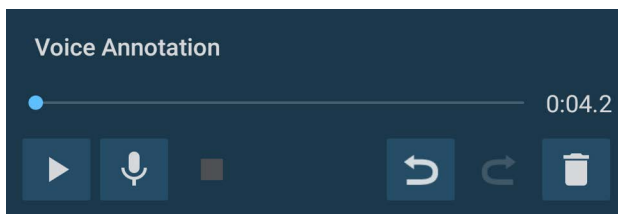

- Tap the **Microphone button** to record. Speak clearly into the microphone.
- Tap the **Stop button** to end recording. The length of the recording is displayed.
- Tap the **Microphone button** again to add to the end of the voice recordings.
- Tap the **Play button** to play a voice recording.

Images with linked voice recordings will display a **Voice Annotation** icon in the bottom left corner of the image. Tap this icon to launch the **Voice Annotation window** and play the existing voice annotation.

- Tap the **Delete** icon to delete the recording.

Exam notes

Notes can be added for an examination.

1. Tap the  icon to display the **Exam menu**.
2. Select **Exam Notes** from the drop-down list box ([FIGURE 39. Exam notes](#)).

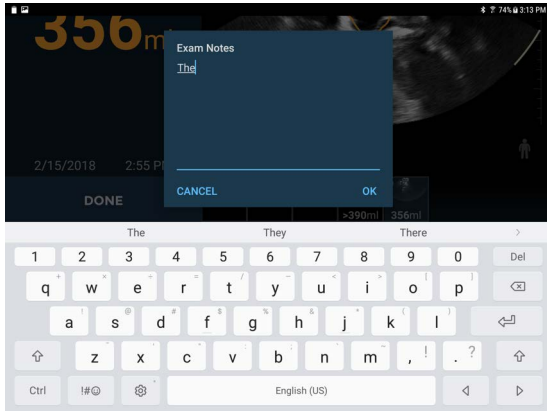

FIGURE 39. Exam notes

3. Use the on-screen keyboard to type notes in the text box.

Entering patient details

Patient details are required if data is saved. Patients may already be stored in the **System**, or they may need to be entered.

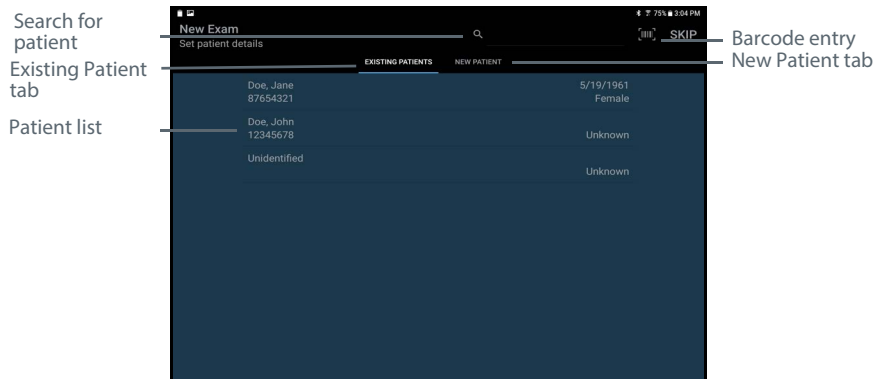



FIGURE 40. Entering patient details

The source for patient names is a preference setting (see [Settings](#)), which may be local storage or a remote server.

The list of patients is displayed under the **Existing Patients** tab. Tap the patient name to select a patient from the list. When querying patients from a remote server, you may need to type a few letters into the search field to display patients.

- The **Search**  icon can be used to find an existing patient.
- Tap the **Barcode**  icon or use a barcode scanner to search using a patient's barcode.
- Tap the **Skip** icon to bypass patient data entry. You will be prompted to enter patient details again when saving the exam.
- Tap the **New Patient** tab to enter the details for a new patient using the on-screen keyboard. Now you can enter the family name, given name, EMR identifier, sex, and date of birth.

Printing

Tap the **Printer**  icon to print to a network (see [Network printer setup \(optional\)](#)) or Bluetooth printer (see [Bluetooth printer setup \(optional\)](#)).

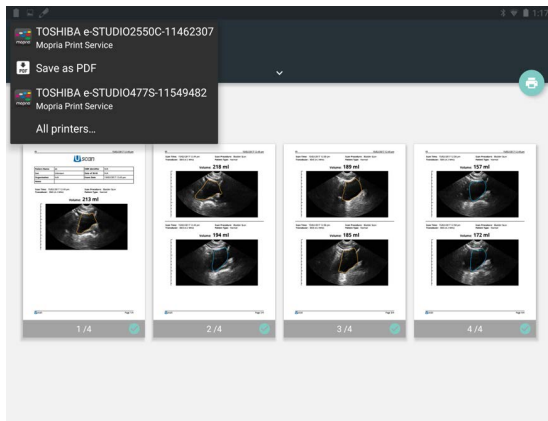



FIGURE 41. Network printing

Network printing uses the Mopria service (see www.mopria.org), which enables printing to thousands of network printer types. The **EchoNous System** display needs to be connected via WiFi to the same network as the printer. To print:

1. Tap the **Printer**  icon.
2. Tap **PRINT ALL** to print all scans or **PRINT SELECTION** to print only selected scans.
3. Select the printer from the drop-down list box.
4. If required, adjust the number of copies, paper size, color, orientation, or any other options provided by the printer.
5. Tap the  button to send to the printer.

Bluetooth printing only prints the current image.

Export

Images, movie clips, and PDF reports can be exported to the display's internal storage for later download to a computer via USB.

1. Tap the  menu icon to display the **Exam menu**.
2. Select **Export** from the drop-down list box.
3. Select **Image/Video** or **PDF Report** from the drop down list.
4. Tap **EXPORT ALL** to export all scans or **EXPORT SELECTION** to export only selected scans.

The images, videos, and PDF reports are saved to the display's internal storage in a subfolder of "EchoNous Export." The subfolder is named using the patient name, date, and time of the exam (PatientName - YYYYMMDD_HHMMSS).

Scan review

Scan review is available when local storage is enabled.

- ★ Tap the **Scan Review** icon on the **Home screen** to review saved examinations in local storage.

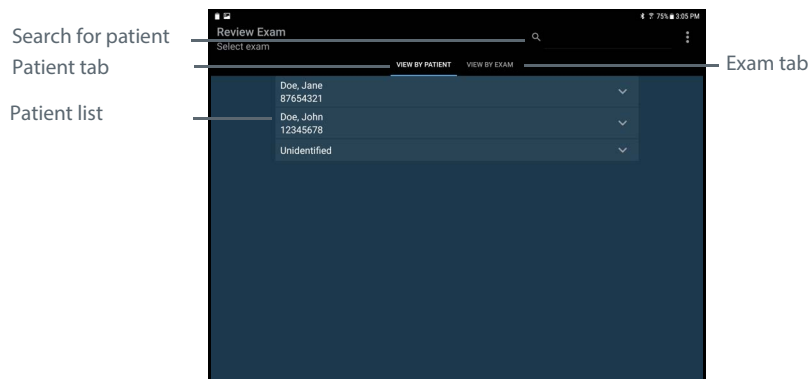

FIGURE 42. Scan Review

The data is arranged under patients, with each patient being able to link one or more examinations and each examination containing one or more images and/or movies (an image/movie may be a bladder volume measurement or an ultrasound scan of another organ).

A list of patients will be displayed. Tap the patient to display the list of exams attached to that patient. To view all exams, tap the **View by Exam** tab.

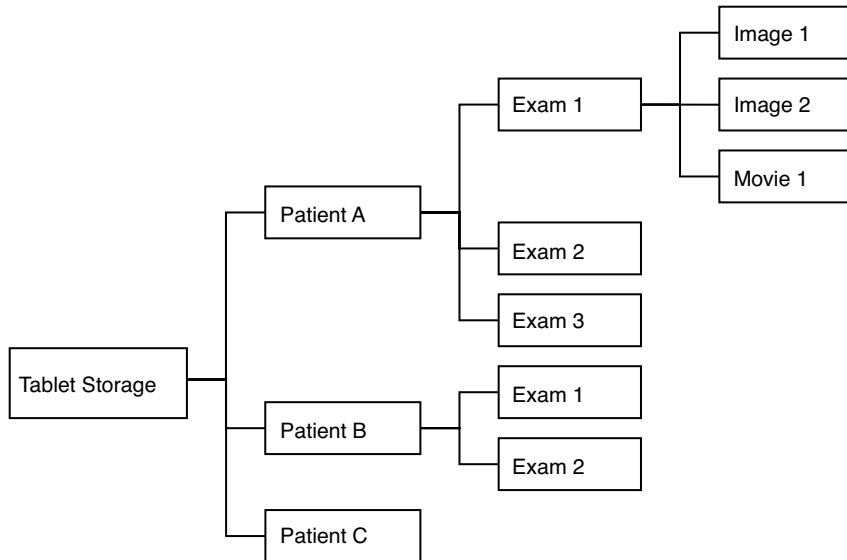



FIGURE 43. Relationship between patients, exams and images

Use the search function to find a patient and associated exams. Tap the patient arrow  to view all exams associated with a patient. Tap the exam to open and review the images.

Deleting exams and patients

To delete an exam or a patient from local storage:

1. Tap **Scan Review** on the **Home screen**.
2. Tap and hold the exam or patient. The exam or patient will be checked, and check boxes appear next to other patients and exams (see [FIGURE 44. Deleting Patients](#)).

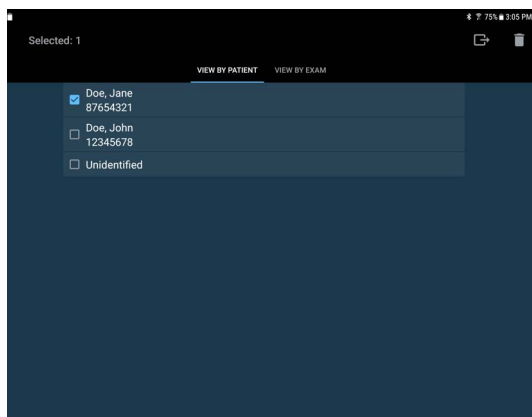



FIGURE 44. Deleting Patients

3. Tap other patient and exam check boxes as required, and then tap the **Trash**  icon at the top right of the screen to delete all checked exams and patients.

Alternatively, use the menu by tapping the  icon. The following menu options are available:

- Use **Delete patients without exams** to delete any patients with no associated exams.
- Use **Delete All** to delete all but the open exam(s).
- Use **Delete Oldest** to create space on the local storage. At least 10% of the oldest exams are deleted.



Data security

Data security is embedded in the **System** as follows:

- The **System** can be locked by a PIN or password. No user will be able to access any data on the **System** without access to the pin or password.
- All data saved on the **System** is encrypted. Where the **System** has been stolen, no data will be accessible without the PIN or password.
- Secure Wi-Fi protocols are supported, enabling data to be securely saved to remote storage, with no local storage of patient data.
- No Internet ports are open. In the event a third party is able to access the **System**, they will not be able to access any data without the PIN or password.
- No third party applications are able to be installed or run on the **System**, preventing malware and viruses.

Setting a device password

To set a device PIN or password as follows:

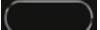
1. From the **Home screen** tap  menu, tap **Settings**, and select **System Settings**.
2. Select Security  Lock screen and security
Lock screen, Fingerprints
3. Tap Screen lock type  Screen lock type
Swipe
4. Select PIN **PIN** or Password **Password**.
5. Enter the PIN or password.
6. Tap Continue **CONTINUE**
7. Confirm the pin or password.
8. Tap OK **OK**
9. Select your notification content preference.
10. Tap **Home**  to return to **Home Screen**.

INTENTIONALLY LEFT BLANK

CHAPTER 5 Maintenance and Troubleshooting

Maintenance

	<ul style="list-style-type: none">• No modification of this equipment is allowed.• This device contains no user-serviceable parts. Please contact EchoNous customer support or your EchoNous distributor for maintenance or repair.
-----------------------------------------------------------------------------------	----------------------------------------------------------------------------------------------------------------------------------------------------------------------------------------------------------------------------------------------------------------------------

The **System** requires no routine or periodic maintenance on either hardware or software components.

Inspect the transducer and display unit housings, connectors, and cables prior to each use for cracks; if cracks are found, discontinue using the device immediately. Contact [EchoNous](#) Customer Support or your EchoNous distributor to arrange repair or replacement.

If the **System** behaves in an abnormal manner or when damage is suspected, discontinue using the device immediately. Contact [EchoNous](#) Customer Support or your EchoNous distributor to arrange repair or replacement.

The **System** must be returned to EchoNous Customer Support or your EchoNous distributor to arrange battery replacement. If you plan to dispose of the **System**, recycle electrical equipment and batteries where possible, and abide by local disposal guidelines and directives.

	<ul style="list-style-type: none">• Ultrasound transducer crystals are fragile and easily damaged if knocked, dropped, or excessively vibrated.• Avoid unnecessary bending or winding of the connecting cable.
-------------------------------------------------------------------------------------	---------------------------------------------------------------------------------------------------------------------------------------------------------------------------------------------------------------------------------------

If the **System** is dropped or suffers a heavy knock:

- Inspect the device. If you discover major damage do not use the device; report the fault to your **EchoNous** distributor for repair.
- Switch on and check normal function of all controls.
- Tap **Menu, Settings, Maintenance**, then **Bladder Probe Calibration** to check the bladder probe inertial sensors.

If there are any concerns about operating the device, report the faults to your **EchoNous** distributor for inspection and/or repair.

Battery maintenance

You cannot remove the **EchoNous System** display battery. Take precautions if the device is not used for long periods of time. Before storing, fully charge the device. Turn the device off when placing in storage, and store at ambient or cooler temperature. Take the device out of storage at least every six months and recharge the device.



The batteries should be charged every six months at a minimum, even if you are not using your device. When storing for greater than three days, store at ambient or cooler temperature.

Probe cleaning and disinfection



- Remove all particles and other matter from crevices and surfaces when cleaning the System and components.
- The device is supplied unsterile.
- Clean and disinfect the transducer between patients.
- Before cleaning or disinfection, turn the System off and disconnect it from the power supply.
- Always disconnect the USB cable from the display tablet before cleaning and disinfection.
- After cleaning, you must disinfect the EchoNous Vein and EchoNous Bladder probes by following the appropriate instructions.
- Always use protective eyewear and gloves when cleaning and disinfecting any equipment.
- Before disinfection, clean the probe by following the appropriate instructions to remove all gels, fluids, and particulates that may interfere with the disinfection process.
- Do not submerge the probe, display unit, or power supply (charger) as electric shock could result. The EchoNous Bladder and EchoNous Vein probes are IPX4, which allows water splashing from all directions. The display may have no protection against ingress of water. Refer to the display user manual.
- Clean and disinfect the System before placing in a bag for transport. Use the supplied EchoNous probe holder to store the probe. Clean and disinfect the probe holder regularly.
- Use only EchoNous-recommended disinfectants. Using a non-recommended disinfecting wipe can damage the probe and void the warranty.
- When cleaning and disinfecting the probe, do not allow any fluid to enter electrical connections or metal portions of the USB connector.
- Use abrasive cleaners, isopropyl alcohol or solvents sparingly and, if used, immediately clean and remove residual substances from the System.
- Do not heat sterilize any part of the system.



- Always inspect the probe before and after cleaning, disinfection, or use. Check the lens face, cable, housing, seams, and connector for signs of damage such as cracks, chips, abrasions, or leaks. To avoid the risk of electrical hazards, do not use the probe if there is any sign of damage.



- Excessive use of Trophon EPR or Trophon2 disinfection system for HLD may result in degradation of performance.

Cleaning

Display

For cleaning requirements of the display refer to its user manual.

EchoNous Vein and EchoNous Bladder probes

The following cleaning instructions must be followed for the EchoNous Vein and EchoNous Bladder probes. The probes must be cleaned after each use. Cleaning the probes is an essential step before effective disinfection.

CLEANING STEPS

1. After each use, disconnect the USB cable from the display tablet.
2. Remove any accessories attached to, or covering the probe, such as needle guide, needle bracket, and sheath (probe cover).

	<ul style="list-style-type: none">• The needle guide is single-use disposable.• The needle bracket is reusable and must be cleaned using the same methods as the probe.
-----------------------------------------------------------------------------------	------------------------------------------------------------------------------------------------------------------------------------------------------------------------------------------------

3. Remove all ultrasound gel from the probe face by using an approved pre-saturated disinfectant wipe. Choose an EchoNous approved wipe from [Table 5.1 Presaturated wipes for EchoNous probes](#).
4. Obtain a new wipe. Remove any particulate matter, gel, or fluids that remain on the probe using a new presaturated wipe from [Table 5.1 Presaturated wipes for EchoNous probes](#). If necessary, clean the probe with additional wipes to remove all visible contaminants.

Disinfection

EchoNous Vein and EchoNous Bladder probes intermediate-level disinfection

Use the following steps to intermediate-level disinfect the EchoNous Vein and EchoNous Bladder probes whenever they have **not** come in contact with blood or bodily fluids (non-critical use).

After cleaning, choose an intermediate-level disinfectant that is from the list in [Table 5.1 Presaturated wipes for EchoNous probes](#). Follow the instructions on the disinfectant label for the minimum wet contact time.

Table 5.1 Presaturated wipes for EchoNous probes

Product	Company	Active Ingredient(s)	Contact Condition
Sani-Cloth Plus	PDI Inc.	n-Alkyl (68% C12, 32% C14) dimethyl ethylbenzyl ammonium chlorides. 0.125% n-Alkyl (60% C14, 30% C16, 5% C12, 5% C18) dimethyl benzyl ammonium chlorides. 0.125%	3 min wet contact time for disinfection

1. With a new wipe, clean the cable and transducer, starting from the exposed cable, wiping toward the probe head to avoid cross-contamination.
2. Observe the required wet contact time. Monitor the probe for wet appearance. Reapply with a new wipe if no longer wet.
3. Examine the probe for damage, such as cracks, splitting, or sharp edges. If damage is evident, discontinue using the probe, and contact your EchoNous representative.

Refer to [EchoNous](#) website for additional disinfection options.

	Minimize the application of alcohol-based disinfectant to colored overmold materials. Long-term use may result in material degradation. If alcohol-based disinfectant is applied to the overmold, immediately remove it by wiping with a damp cloth.
-------------------------------------------------------------------------------------	------------------------------------------------------------------------------------------------------------------------------------------------------------------------------------------------------------------------------------------------------

The ultrasound probe and transducer may be disinfected using a wipe or spray method of disinfection.

1. First, clean the ultrasound probe and transducer as above.
2. Then wipe or spray the probe and transducer with disinfectant, and leave it on for the disinfectant manufacturer's recommended contact time.
3. Remove any residue with a soft cloth moistened with water. Do not allow any solutions to dry on the probe and transducer.

	After cleaning or disinfection examine the ultrasound probe and display as appropriate for cracks or leaks, and if damage exists discontinue use of the system and contact EchoNous customer support or your EchoNous distributor.
-------------------------------------------------------------------------------------	----------------------------------------------------------------------------------------------------------------------------------------------------------------------------------------------------------------------------------------------------

Disinfecting Using ARS (Automated Reprocessing System)

Compatible EchoNous probes may be disinfected using approved AR systems listed in the table below. Follow the manufacturer's instructions for disinfection using those products.

For additional detail contact [EchoNous](#).

TABLE 6. ARS Compatible EchoNous Probes

AR Manufacturer	AR Systems	Bladder Probe	Vein Probe
Nanosonics	Trophon EPR Trophon2		✓

Troubleshooting

TABLE 7. Troubleshooting

Symptom	Possible cause	Remedy
The display does not turn on	Flat battery	Connect to the display charger and turn on.
The System battery fails to recharge after a period of heavy use. The battery status indicates batteries are not recharging despite the system being connected to a power supply (charger)	Battery temperature exceeds 45°C	Allow device to cool for 10 - 15 minutes, then try charging the battery again.
The System becomes non-responsive or will not power up after recharge.	Unknown system error	Shut down the display and reboot.
Any error message not resolved by the actions above or the action suggested on screen.	Various errors	Error messages generated by the System will be accompanied by a description of the error or an error code. If unresolved, contact EchoNous customer support or your distributor with the message and code.

Clinical troubleshooting

Scan technique impacts the quality of the ultrasound image during a bladder measurement and, therefore, impacts the accuracy of the measurement.

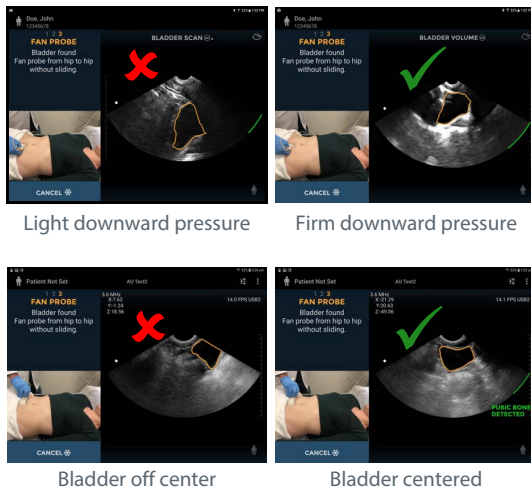

FIGURE 45. Scan Technique

The following tips assist in producing reliable and repeatable measurements:

- Move and angle the probe so the center of the bladder is in the center of the ultrasound image.
- Apply moderate downward pressure. On large patients, apply firm downward pressure.
- Fan the probe at a smooth speed, aiming to complete the measurement in less than five seconds.
- Pivot and do not slip or slide the tip of the probe.

EchoNous customer support

If problems persist or recur, contact [EchoNous](#) Customer Support or your EchoNous distributor.

For other countries, refer to EchoNous website (see [Contact information](#)).

CHAPTER 6 Connectivity and Accessories

Accessories

The following accessories are supported by the **EchoNous System**:

- Wireless printer
- Wireless barcode scanner
- EchoNous Power Supply (P003198)
- EchoNous Stand Power Supply (P004016)
- EchoNous Type C Power Supply (P005179)
- EchoNous AI Station Stand (P005149)
- MODO Stand (P004013)
- EchoNous AI Station II Stand (P006259)
- EchoNous AI Station Stand Power Supply (P005332)
- EchoNous AI Station Stand Lower Bucket Assembly (P005181)
- EchoNous Carrying Case (P005900)

System connectivity



- Do not touch any device connectors while in physical contact with the patient.
- The ultrasound probes are connected to an Android display running EchoNous System software to configure a medical system. The Android display is certified as a component of a medical electrical system to EN IEC 60601-1 Edition 3.1.
- Do not connect the EchoNous System display to external computers or peripherals using the USB port unless the System is outside the patient area. Failure to comply with these guidelines may result in electric shock.
- Mounting the EchoNous System display on the EchoNous AI Station or MODO Stand is configuring a medical electrical system. Only use the EchoNous AI Station or MODO Stand accessory (P006259, P004013, or P005149).
- Only connect accessories or items that are specified as being compatible with the EchoNous System. Contact EchoNous customer support or your EchoNous distributor for information on compatible accessories and systems.
- Connecting electrical equipment to a Multiple Socket Outlet (MSO) effectively leads to creating a medical electrical system, and can result in a reduced level of safety.
- MSOs provided with the medical electrical system (if provided with the medical electrical system) are to be used only for supplying power to the tablet display and optional printer in non-operating mode.
- Risk of shock or personal injury when connecting any equipment that has not been supplied as a part of the medical electrical system to the MSO.
- Do not connect an additional MSO or extension cord to the medical electrical system.
- Only use MSOs provided with the medical electrical system (if provided with the medical electrical system) for supplying power to equipment that is intended to form part of the medical electrical system.

Power sources

During operation, the **System** is electrically powered by an internal battery. The battery can be recharged by a mains-powered supply via the provided power supplies (chargers). The battery can be recharged on any of the three EchoNous AI Stations via the EchoNous HUB.

Internal battery

The **EchoNous System Display** contains an internal battery.

When powered by a fully charged battery, the **System** will run for more than 12 hours with an average operating regime of 4 x 1 minute scans per hour.

From a fully discharged state, while the **System** is in sleep mode, the battery recharges to 80% capacity when connected to a display power supply (charger) for three hours.

Power supplies (chargers)



- Recharge the System only with the power supplies (chargers) provided.
- The EchoNous power supplies are dedicated units to be used exclusively only with the EchoNous System.
- Do not open or modify the EchoNous Power Supply P003198 or any other supplied power supplies - Risk of electric shock
- Only connect to an AC supply rated at 100-240V and 50-60Hz.
- Do not use the device or power supplies (chargers) if there are signs of damage.

EchoNous stand setup

Three optional EchoNous AI Station stands are available:

- MODO Stand™ (P004013)
- EchoNous AI Station™ (P005149)
- EchoNous AI Station™ 2 (P006259)



- Mounting the EchoNous System display on a mobile stand is configuring a medical electrical system. Only use an EchoNous provided mobile stand accessory.
- The ultrasound probes are connected to an Android display running EchoNous software to configure a medical system. The display has been certified by EchoNous as part of a medical electrical system to EN IEC 60601-1 Edition 3.1.
- Do not connect the EchoNous System display to external computers or peripherals using the USB port unless the System is outside the patient area. Failure to comply with these guidelines may result in electric shock.
- Only connect accessories or items that are specified as being compatible with the EchoNous System. Contact EchoNous customer support or your EchoNous distributor for information on compatible accessories and systems.
- Connecting electrical equipment to an MSO effectively leads to creating a medical electrical system and can result in a reduced level of safety.
- MSOs provided with the medical electrical system (P004013) are to be used only for supplying power to the tablet display and optional printer in non-operating mode.
- Risk of shock or personal injury when connecting any equipment that has not been supplied as a part of the medical electrical system to the MSO.
- Do not connect an additional MSO or extension cord to the medical electrical system.
- MSOs provided with the medical electrical system (P004013) (if provided with the medical electrical system) should only be used for supplying power to equipment that is intended to form part of the medical electrical system.

MODO Stand setup

- For installation instructions on MODO Stand, follow the instructions shipped with the product.
- To configure the system for the Samsung tablet with MSO, refer to the Stand Upgrade Kit Guide (P005465).
- To configure the system for the Samsung tablet without the MSO, refer to the MODO Stand Upgrade Kit Guide (P006018).
- All the quick start guides are shipped with the product and are available in the pen drive.

EchoNous AI Station setup

- For installation instructions on the AI station, refer to the AI Station Assembly Guide (P005339).
- To configure the system for mobile use, refer to the AI Station Tablet Setup Guide (P005447).
- Both quick start guides are shipped with the product and are available in the pen drive.

USING THE ECHONOUS AI STATION MOBILE STAND

TABLE 1. Safe working loads and installation heights of all components

Component	Mounting Height Range (measured from top of central column)	Safe Working Load
Tablet holder	0" - 11" (bottom of range limited by safety stop) 0 cm - 28 cm	As configured (no storage)
Handle bar assembly	13" - 23" (top of range limited by safety stop) 33 cm - 58 cm	3 lbs on each side (6 lbs total) 1.3 kg on each side (2.6 kg total)
Lower bin assembly	30" - 36" 76 cm - 91 cm	4 lbs on each side (8 lbs total) 1.8 kg on each side (3.6 kg total)
Cord wrap	Below lower bin	As configured (no storage)

	The cord wrap must be installed as the lowest component on the AI Station Mobile Stand to protect the handle bar assembly against falling down into the caster base.
-----------------------------------------------------------------------------------	----------------------------------------------------------------------------------------------------------------------------------------------------------------------

LOCKING THE WHEELS

All four caster wheels are capable of locking. Press the lock button with your foot. The caster is locked when the lock button is out. The caster is unlocked when the lock button is in.

ADJUSTING THE HEIGHT OF COMPONENTS

All components are capable of being adjusted up or down the central column of the AI Station.

1. Press the thumb button on the collar.
2. Support the weight of the component with one hand.
3. While depressing the thumb button, pull the collar handle open. The handle may be tightly engaged and requires a screw driver to gently pry open.
4. With the collar handle open, use both hands to move the component to the desired position.
5. Push the collar handle closed. The thumb button on the collar should automatically fall into place.

	<ul style="list-style-type: none"> • When opening the collar handles for components on the AI Station, it is important to support the component's weight to avoid damage or injury from falling components. • When adjusting the height of the display unit on the EchoNous AI Station, it is important to safely manage the DC power cord to avoid damage to the cord and risk of electric shock.
-------------------------------------------------------------------------------------	----------------------------------------------------------------------------------------------------------------------------------------------------------------------------------------------------------------------------------------------------------------------------------------------------------------------------------------------------------------------------------------------------------------------------

When adjusting the mobile stand dock downward, ensure that enough power cord is available to reach the new height before moving. Remove the cord from the storage track and pull gently on the cord as it exits the top of the column. If the cord does not move freely, you may need to remove the plastic cap at the top of the column. After moving the dock to its new position, replace the cord in the column storage track. Push any extra cord back into the column via the top. You may need to remove the cap to push the extra cord back in.

EchoNous AI Station 2 setup

For information on setting up AI Station 2, please reference the EchoNous AI Station 2 User Guide (P006275-001, Rev A).

EchoNous AI Station power management

Charging

The EchoNous AI Stations can be fully charged using the AI Station stand power cord. To charge the system, first ensure that the tablet display is turned on, then connect the power cord to an AC source.

Sleep mode

In order to conserve The battery, the AI Station hub and attached probes go into sleep mode when the tablet display goes to sleep. The AI Station hub sleep mode is controlled by a motion sensor and will wake up when the stand is moved.

If the tablet display is turned on without moving the stand, the message shown in [FIGURE 46. AI Stand Power Saving](#) will be displayed.

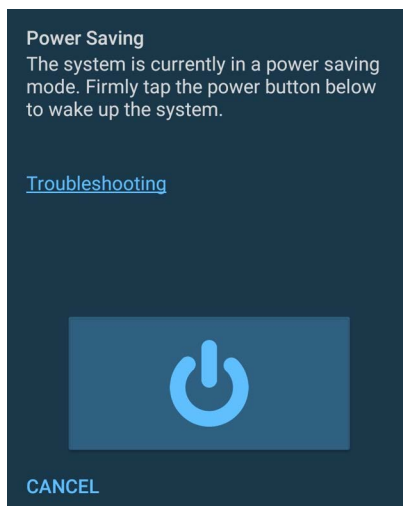

FIGURE 46. AI Stand Power Saving

- ★ To wake up the **System**, follow the instructions and firmly tap the power button displayed on the screen.

EchoNous AI Station troubleshooting

- If the **System** does not wake up after following the wake up instructions, disconnect and then reconnect the USB cable connecting the HUB to the tablet display.
- If this is unsuccessful, connect the power cord to an AC source.
- If the **System** is still not responding, restart the tablet display by holding down the power button and selecting *Restart*.
- If the **System** remains unresponsive or a HUB fault error is displayed, please contact [EchoNous](#) support.

Cleaning

EchoNous recommends the use of a soft cloth, lightly dampened with warm water or a mild soap solution for cleaning the AI Station. Wipe surfaces with the moist cloth, and towel dry with a soft clean cloth.

Disinfection

Where bodily fluid or other contamination is expected, the EchoNous stands can be disinfected using the spray and wipe method with a variety of disinfection products. Follow the manufacturers recommended method.

The following disinfecting means can be used with the **MODO Stand**:

- Sani-Cloth[®] Active by *PDI* of Flint, UK
- Tuffie 5 Wipes by *VernaCare* of Lancashire, UK
- Protex Disinfectant Wipes by *Parker Laboratories* of New Jersey
- Any Isopropyl alcohol impregnated wipes with $\leq 70\%$ w/w alcohol

The following disinfecting means can be used with the **AI Station** and **AI Station 2**:

- Clorox Hydrogen Peroxide wipes
- Clorox Bleach wipes
- PDI Sani-Cloth Plus

Refer to [EchoNous](#) website for additional disinfection options.

1. First, clean the mobile stand as above.
2. Wipe or spray the mobile stand with disinfectant, and leave for the disinfectant manufacturers recommended contact time.
3. Remove any residue with a soft cloth moistened with water.

INTENTIONALLY LEFT BLANK

CHAPTER 7 Specifications

System dimensions

TABLE 1. Probe dimensions

Component	Height	Width	Depth	Weight
EchoNous Bladder probe	135mm (5.31 inches)	60mm (2.36 inches)	24mm (0.945 inches)	~181g (6.4 oz)
EchoNous Vein probe	100mm (3.94 inches)	39mm (1.54 inches)	21mm (0.827 inches)	~50g (1.76 oz)

TABLE 2. Cable dimensions

Component	Length
EchoNous Vein USB micro to USB C	813mm (32 inches)
Connecting cable, tablet display	1800mm (70.9 inches)

TABLE 3. Display dimensions

Component	Height	Width	Depth	Weight
Samsung S8 tablet	254 mm (9.99 inches)	165 mm (6.51 inches)	6.3 mm (0.25 inches)	503 g (1.11 lbs)
Samsung S7 tablet	254 mm (9.99 inches)	165 mm (6.51 inches)	6.4 mm (0.25 inches)	498 g (1.2 lbs)
Samsung S6 tablet	245mm (9.63 inches)	160mm (6.28 inches)	5.5mm (0.22 inches)	420g (14.82 oz)
Samsung S3 tablet	237mm (9.34 inches)	169mm (6.65 inches)	6mm (0.24 inches)	429g (15.13 oz)

Environmental operating and storage conditions

The **EchoNous System** is intended to be used and stored in normal ambient conditions inside a medical facility.

TABLE 4. Operating, charging, transport, and storage condition ranges





	Operating	Transport and Storage
Temperature (°C)	5 (41°F) – 40°C (104°F) 	-20 (-4°F) – 50°C (122°F) 
Relative humidity (non-condensing)	15–90%	10–93%
Pressure	70–101.5 kPa (10.3-14.7 psi)	50–101.5 kPa (7.3-14.7 psi)

TABLE 5. Charging condition ranges

	Charging
Temperature (°C)	5 (41°F) – 40°C (104°F) 
Relative humidity (non-condensing)	20–80%
Pressure	70–101.5 kPa (10.3-14.7 psi)

Mode of Operation

The **System** enforces scanning limits when the display battery is at or below 5%.

	After storing at extreme temperatures, check the transducer surface temperature before applying to a patient. A cold or hot surface may burn a patient.
	Only operate, charge, and store the System within the approved environmental parameters.

Power supplies (chargers)

For the Samsung tablet display, the power supply is EchoNous Type C power supply (P005179).

- Input: 100-240V AC supply 50-60Hz
- Output: 5.0V ±0.25V at 2.0A maximum current

Internal battery

- For the Samsung S3 tablet display, the battery is a 6000 mAh Li-ion polymer type.
- For the Samsung S6 tablet display, the battery is a 7040 mAh Li-ion type.

- For Samsung S7 and Samsung S8 tablet displays, the battery is a 8000mAh Li-Ion type.
- The AI Station HUB contains a Lithium Metal 3V / 45 mAh coin cell battery.

Measurement accuracy

Measurements reflect a physical property, such as area or volume for interpretation by a clinician. They do not account for variations in acoustic speed of the body, which can vary significantly.

TABLE 6. Measurement accuracy

Measurement	Units	Range	Accuracy	Modes
Distance				
Axial (bladder)	cm	Full scale	$\pm 5\%$ or $\pm 0.1\text{cm}$	B-mode
Lateral (bladder)	cm	Full scale	$\pm 5\%$ or $\pm 0.3\text{cm}$	B-mode
Axial (vein)	cm	Full Scale	$\pm 5\%$ or $\pm 0.1\text{cm}$	B-mode
Lateral (vein)	cm	Full Scale	$\pm 5\%$ or $\pm 0.1\text{cm}$	B-mode
Volume¹	ml	0-999ml	$\pm 10\%$ or $\pm 10\text{ml}$	3D

¹ When used as per instructions scanning a bladder in a tissue equivalent phantom.

Degree of protection against ingress of water

The EchoNous Bladder probe and cable assembly is IPX4. The probe is IPX7 from the probe face to the level of cable strain relief. See [FIGURE 47. Water protection for EchoNous Bladder probe](#).



FIGURE 47. Water protection for EchoNous Bladder probe

The EchoNous Vein probe and cable assembly is IPX4. The probe is IPX7 from the probe face to the level of cable strain relief. See [FIGURE 48. Water protection for EchoNous Vein probe.](#)



FIGURE 48. Water protection for EchoNous Vein probe

INTENTIONALLY LEFT BLANK

Ergonomics



Avoid musculoskeletal strain with prolonged use of the System by following the guidelines below.

The **System** is intended for quick-look applications by qualified health professionals. It is not intended for continual use in radiology or other departments. If you need to use the device for a continual period, take the following precautions:

- Position yourself comfortably, either with a chair with appropriate lower back support or by sitting or standing upright.
- Minimize twisting, relax your shoulders, and support your arm with a cushion.
- Hold the probe lightly, keep your wrist straight, and minimize the pressure applied to the patient.
- Take regular breaks.

External materials

The parts of the device that come into patient contact are biocompatible as assessed in EN ISO10993-1.

Disposal



Do not incinerate or discard the device in general waste at end of life. The lithium battery is a potential environmental and fire safety hazard.

The **System** contains lithium-polymer batteries and the **System** should be disposed of in an environmentally responsible manner in compliance with federal and local regulations. It is recommended that you take the **System** to a recycling center which specializes in the recycling and disposal of electronic equipment.

The AI Station HUB contains a lithium metal battery and should be disposed of in an environmentally responsible manner in compliance with federal and local regulations.



Where the device has been exposed to biologically hazardous material, EchoNous recommends that you dispose of the device using biohazard containers and in compliance with federal and local regulations. EchoNous recommends the **System** is taken to a waste center which specializes in the disposal of biohazard waste.

Electrical safety



- The System complies with the requirements of EN IEC 60601-1 Edition 3.1. To avoid the risk of injury or electrical shock, comply with all safety instruction and warnings.
- Do not touch the any device connectors while in physical contact with the patient.
- The ultrasound probes are connected to a supplied Android display running EchoNous System software to configure a medical system. The Android display is certified to EN IEC 60601-1 Edition 3.1 as a component of a medical electrical system.
- Do not connect the EchoNous System display to external computers or peripherals using the USB port unless the System is outside the patient area. Failure to comply with these guidelines may result in electric shock.
- Only connect accessories that are specified as being compatible with the EchoNous System. Contact EchoNous customer support or your EchoNous distributor for information on compatible accessories and systems.
- Connecting electrical equipment to an MSO effectively leads to creating a medical electrical system, and can result in a reduced level of safety.
- MSOs provided with the medical electrical system (if provided with the medical electrical system) are to be used only for supplying power to the tablet display and optional printer in non-operating mode.
- Risk of shock or personal injury when connecting any equipment that has not been supplied as a part of the medical electrical system to the MSO.
- Do not connect an additional MSO or extension cord to the medical electrical system.
- MSOs provided with the medical electrical system (if provided with the medical electrical system) should only be used for supplying power to equipment that is intended to form part of the medical electrical system.
- Avoid any unnecessary strain on the mains power supply cord.
- When adjusting the height of the display unit on the EchoNous AI Station mobile stand, it is important to safely manage the DC power cord to avoid damage to the cord and risk of electric shock.

Electromagnetic compatibility (EMC)

	<p>The System complies with the Electromagnetic Compatibility requirements of AS/NZ CISPR 11:2015 and EN IEC 60601-1-2:2014. However, electronic and mobile communications equipment may transmit electromagnetic energy through air and there is no guarantee that interference will not occur in a particular installation or environment. Interference may result in artifacts, distortion, or degradation of the ultrasound image. If the System is found to cause or respond to interference, try re-orienting the System or the affected device, or increasing the separation distance between the devices. Contact EchoNous customer support or your EchoNous distributor for further information.</p>
	<p>The System contains sensitive components and circuits. Failure to observe proper static control procedures may result in damage to the System. Any faults should be reported to EchoNous or your EchoNous distributor for repair.</p>

The **System** is intended for use in the electromagnetic environment specified below. The user of the **System** should assure that it is used in such an environment.

TABLE 1. Guidance and manufacturer's declaration: electromagnetic emissions

Emissions test	Compliance	Electromagnetic environment: guidance
RF emissions CISPR 11	Group 1	The System is suitable for use in all establishments other than domestic and those directly connected to the public low-voltage power supply network that supplies buildings used for domestic purposes.
RF emissions CISPR 11	Class A	
Harmonic emissions IEC 61000-3-2	Class A	
Voltage fluctuations/ flicker emissions IEC 61000-3-3	Complies	

¹ The **System** has Class A compliance in meaning it is suitable for use in all establishments other than domestic and those directly connected to the public low-voltage power supply network that supplies buildings used for domestic purposes. If the **System** is found to cause or respond to interference follow the guidelines in the warning section above.

The user should assure the **System** is used in the electromagnetic environment specified below.

TABLE 2. Guidance and manufacturer's declaration: electromagnetic immunity

Immunity test	IEC 60601 test level	Compliance level	Electromagnetic environment: guidance
Electrostatic discharge (ESD) IEC 61000-4-2	±8 kV contact ±15kV air	±8 kV contact ±15kV air	Floors should be wood, concrete or ceramic tile. If floors are covered with synthetic material, the relative humidity should be at least 30%.
Electrical fast transient/burst IEC 61000-4-4	±2 kV for power supply lines	±2 kV for power supply lines	Mains power quality should be that of a typical commercial or hospital environment.
Surge IEC 61000-4-5	± 1kV line(s) to line(s) ± 2kV line(s) to earth	± 1kV differential mode ± 2kV common mode	Mains power quality should be that of a typical commercial or hospital environment.
Voltage dips, short interruptions and voltage variations on power supply input lines IEC 61000-4-11	<5% U_T ¹ (>95% dip in U_T) for 0.5 cycle 40% U_T (60% dip in U_T) for 5 cycles 70% U_T (30% dip in U_T) for 25 cycles <5% U_T (>95% dip in U_T) for 5 sec	<5% U_T ¹ (>95% dip in U_T) for 0.5 cycle 40% U_T (60% dip in U_T) for 5 cycles 70% U_T (30% dip in U_T) for 25 cycles <5% U_T (>95% dip in U_T) for 5 sec	Mains power quality should be that of a typical commercial or hospital environment.
Power frequency (50/60 Hz) magnetic field IEC 61000-4-8	3 A/m	3 A/m	Power frequency magnetic fields should be at levels characteristic of a typical location in a typical commercial or hospital environment.

TABLE 2. Guidance and manufacturer's declaration: electromagnetic immunity (Continued)

Immunity test	IEC 60601 test level	Compliance level	Electromagnetic environment: guidance
^{2,3} Conducted RF IEC 61000-4-6	3 Vrms 150kHz 80MHz	3 Vrms	Portable and mobile RF communications equipment should be used no closer to any part of the system , including cables, than the recommended separation distance calculated from the equation applicable to the frequency of the transmitter Recommended separation distance $d = 1.2 \sqrt{P}$
Radiated RF IEC 61000-4-3	3 V/m 80MHz 2.5 GHz	3 V/m	$d = 1.2 \sqrt{P}$ 80MHz to 800MHz $d = 2.3 \sqrt{P}$ 800MHz to 2.5GHz Where <i>P</i> is the maximum output power rating of the transmitter in watts (W) according to the transmitter manufacturer and <i>d</i> is the recommended separations distance in meters (m). Field strengths from fixed RF transmitters, as determined by an electromagnetic site survey ⁴ , should be less than the compliance level in each frequency range ⁵ . Interference may occur in the vicinity of equipment marked with the following symbol. 

Notes for Table 8.2

- ¹ U_T is the AC mains voltage prior to application of the test level
- ² At 80MHz and 800 MHz, the higher frequency range applies
- ³ These guidelines may not apply in all situations. Electromagnetic propagation is affected by absorption and reflection from structures, objects and people.

- 4 Field strengths from fixed transmitters, such as base stations for radio (cellular/cordless) telephones and land mobile radios, amateur radio, AM and FM radio broadcast and TV broadcast cannot be predicted theoretically with accuracy. To assess the electromagnetic environment due to fixed RF transmitters, an electromagnetic site survey should be considered. If the measured field strength in the location in which **the system** is used exceeds the applicable RF compliance level above, **the system** should be observed to verify normal operation. If abnormal performance is observed, additional measures may be necessary, such as re-orientating or relocating **the system**.
- 5 Over the frequency range 150kHz to 80MHz, field strengths should be less than 3V/m.



	When using the optional mobile stand, the System can be susceptible to ESD and may require manual intervention. If ESD results in a System error, unplug the probe, and plug it back in to restore operation.
-----------------------------------------------------------------------------------	---------------------------------------------------------------------------------------------------------------------------------------------------------------------------------------------------------------

TABLE 3. Separation distances

Recommended separation distances between portable and mobile RF communications equipment and the EchoNous System			
The System is intended for use in an electromagnetic environment in which radiated RF disturbances are controlled. The customer or user of the System can help prevent electromagnetic interference by maintaining a minimum distance between portable and mobile RF communications equipment (transmitters) and the System as recommended below, according to the maximum output power of the communications equipment.			
Rated maximum output power of transmitter W	Separation distance according to frequency of transmitter m		
	150 kHz to 80 MHz $d=1.2 \sqrt{P}$	80 MHz to 800 MHz $d=1.2 \sqrt{P}$	800 MHz to 2,5 GHz $d=2.3 \sqrt{P}$
0.01	0.12	0.12	0.23
0.1	0.38	0.38	0.73
1	1.2	1.2	2.3
10	3.8	3.8	7.3
100	12	12	23
For transmitters rated at a maximum output power not listed above, the recommended separation distance d in meters (m) can be estimated using the equation applicable to the frequency of the transmitter, where P is the maximum output power rating of the transmitter in watts (W) according to the transmitter manufacturer. NOTE 1: At 80 MHz and 800 MHz, the separation distance for the higher frequency range applies. NOTE 2: These guidelines may not apply in all situations. Electromagnetic propagation is affected by absorption and reflection from structures, objects and people.			

Power supplies (chargers)

The external EchoNous power supplies (chargers) comply with the requirements of EN IEC 60601-1 Edition 3.1.

	Do not open or modify the EchoNous Power Supply (P005179), the EchoNous AI Station power supply (P005332), or any other supplied power supplies - Risk of electric shock
-----------------------------------------------------------------------------------	--------------------------------------------------------------------------------------------------------------------------------------------------------------------------

Biological safety

The device can be disinfected for reuse on immunocompromised and non-immunocompromised patients after:

- Frequent contact with healthy skin (frequent low risk).
- Occasional contact with mucous membranes or contamination with particularly virulent or readily transmissible organisms (occasional intermediate risk).

Acoustic output

	The ALARA principle (As Low As Reasonably Achievable) should be employed for all medical ultrasound exposure.
-----------------------------------------------------------------------------------	---------------------------------------------------------------------------------------------------------------

Ultrasound imaging has been in regular use for over 20 years and has an excellent safety record. Even though there are no known risks of ultrasound imaging, it heats the tissues slightly and may produce small pockets of gas in body fluids or tissues (cavitation). The long-term effects of tissue heating and cavitation are not known.

Given potential does exist for bio-effects with ultrasound exposure, any exposure should be kept As Low As Reasonably Achievable. Scans should only be performed when there is a medical benefit and in the shortest time commensurate with obtaining an adequate study. As the acoustic output of the device does not exceed an MI or TI of 1.0, visual display of MI and TI values is not required. A generic ALARA education program is supplied with your **System** (see enclosed ISBN 1-93004 7-71-1, *Medical Ultrasound Safety*).

TABLE 4. B-mode acoustic output and uncertainties

	I _{SPTA.3} [mW/ cm ²]	TI type	TI Value	MI	I _{PA.3@MI} max [W/ cm ²]
EchoNous Bladder Probe Output	2.57	TIS	0.0366	0.925	90.1
EchoNous Bladder Probe Uncertainties	±8.4%		±8.6%	±4.3%	±8.4%

TABLE 4. B-mode acoustic output and uncertainties (Continued)

	$I_{SPTA.3}$ [mW/ cm ²]	TI type	TI Value	MI	$I_{PA.3@MI}$ max [W/ cm ²]
EchoNous Vein Probe (fundamental) Output	0.961	TIS	0.0088	0.411	69.2
EchoNous Vein Probe (fundamental) Uncertainties	±10.3%		±10.5%	±5.2%	±10.5%
EchoNous Vein Probe (THI) Output	4.27	TIS	0.0271	0.67	102.29
EchoNous Vein Probe (THI) Uncertainties	±10.5%		±10.6%	±5.3%	±10.4%

$I_{SPTA.3}$ Derated spatial peak, temporal average intensity (milliwatts/cm²)

TI Thermal index

MI Mechanical index

$I_{PA.3@MI}$ Derated spatial-peak pulse-average intensity (watts/cm²)

Uncertainties are the cumulative effect of measurement uncertainties.

CHAPTER 9 Advanced device and IT setup

The **System** provides a number of advanced configuration options to enable an institution to set up and manage the devices in their facility.

- Administrators can lock preferences with a password.
- Administrators can implement user management.
- Multiple devices can be set up with common preferences.
- Restrict ultrasound scanning and restrict viewing images during bladder scanning.
- Restrict recording of ultrasound data and bladder data.
- Restrict access to USB storage.

Administrator setup



- From the **Home Screen**, tap  and select **Settings**.
- Select **Administration**.
- Under **Security**, tap **Enable Administrator Password**.
- Enter an administrator password. Ensure you record the password in a secure location and do not forget or lose it.

As soon as an administrator password is set up, preferences and settings can only be changed by the administrator.

Software updates restrictions

- From the **Home Screen**, tap  and select **Settings**.
- Select **Administration**.
- **Automatic Updates Check** – check to automatically check for software updates (remote updates are not available in Japan).
- **Allow USB Software Updates** – check to allow installation of software updates via USB.

User management

1. From the **Home Screen**, tap  and select **Settings**.
2. Select **Administration** then select **Manage Users**.
3. Tap the  icon in the top right of the screen.

4. Enter a Username, Family (Last) name, Given (First) name, and if required set the password (see [FIGURE 1. Add User](#)).

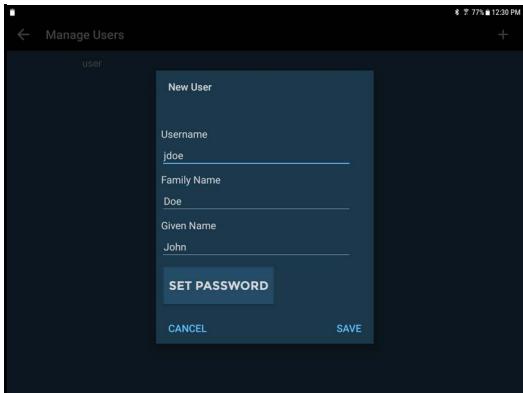

FIGURE 1. Add User

5. Tap **Save** to finish.

You will need to enter a username and password to save patient data (see [FIGURE 2. User Login](#)).

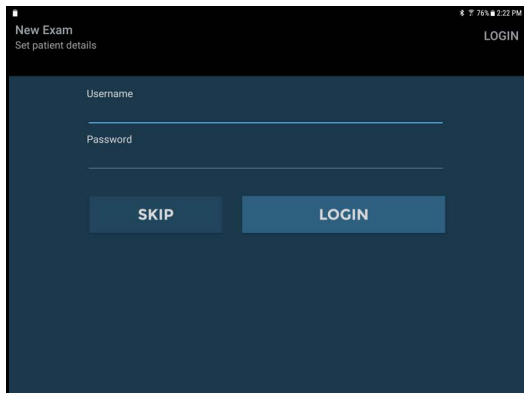

FIGURE 2. User Login

Multiple device setup

To set up multiple devices with identical preferences and users, first configure one device with the required settings (see [Settings](#)).

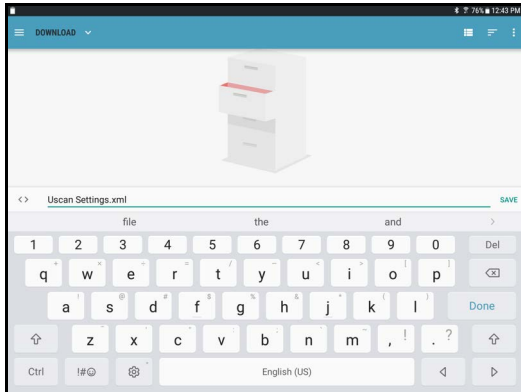



FIGURE 3. Export Settings

Export the settings to a file:

1. From the **Home Screen**, tap  and select **Settings**.
2. Select **Administration** then select **Settings Management**.
3. Select **Export EchoNous System Settings**.
4. Tap **SAVE** to write the settings to an XML file.
5. Copy the XML file from the tablet or handheld display to a host computer (for example by connecting the tablet to a computer by a USB cable and copying the file from the tablet to the computer).

On each of the other systems to be set up, import the settings:

1. Turn the display on, and follow the initial setup instructions (see [Setting up the system](#)).
2. Copy the XML file from the host computer to the display local storage.
3. From the **Home Screen**, tap  and select **Settings**.
4. Select **Administration** then select **Settings Management**.
5. Select **Import EchoNous System Settings**.
6. Select the XML file to import.

Imaging restrictions

To set up a password for accessing Ultrasound Imaging and Vascular Access functionality:

1. From the **Home Screen**, tap  and select **Settings**.
2. Select **Administration** then select **Restrict Imaging**.
3. Enter a password for accessing ultrasound functionality. Ensure you record the password in a secure location and do not forget or lose it.

To require ultrasound scanning password for viewing images during bladder scanning:

1. From the **Home Screen**, tap  and select **Settings**.
2. Select **Administration** then select **Disallow viewing images during Bladder Volume Scanning**.

The ultrasound imaging password is required to view images during bladder volume scanning.

Data recording restrictions

The **System** enables institutions to restrict saving, printing, and exporting ultrasound imaging, vascular access, and/or bladder data.

To restrict ultrasound imaging and vascular access data recording:

1. From the **Home Screen**, tap  and select **Settings**.
2. Select **Administration** then select **Imaging Data** under **Recording**.
3. Select **Do not allow recording** to restrict recording imaging data.

To restrict bladder volume data recording:

1. From the **Home Screen**, tap  and select **Settings**.
2. Select **Administration** then select **Bladder Volume Data** under **Recording**.
3. Select **Allow recording volume only** to restrict recording bladder volume images but allow recording volumes.
4. Select **Do not allow recording** to restrict recording all bladder volume data.

Storage access restrictions

To restrict access to exported images via USB:

1. From the **Home Screen**, tap  and select **Settings**.
2. Select **Administration** then select **Restrict access to exported images via USB** under **Storage Access**.

CHAPTER 10 References

- EN IEC 60601-1:2013 Edition 3.1, Medical Electrical Equipment-Part 1. *General Requirements for Basic Safety and Essential Performance.*
- EN IEC 60601-1-2:2015 Edition 4.0, Medical Electrical Equipment. *General Requirements for Basic Safety and Essential Performance. Collateral Standard. Electromagnetic compatibility disturbances requirements and tests.*
- IEC 60601-2-37:2015 Edition 2.1, *Particular requirements for the basic safety and essential performance of ultrasonic medical diagnostic and monitoring equipment.*
- IEC 60950-1:2005, Information Technology Equipment. *Safety-Part 1: General Requirements.*
- EN ISO 10993-1: 2009, Biological Evaluation of medical devices. *Part 1: Evaluation and testing within a risk management process.*
- ISBN 1-93004 7-71-1, *Medical Ultrasound Safety.*

Glossary

Bladder volume	Volume of urine in the bladder.
Exam	A unique interaction between a clinician and patient. Up to 50 images may be saved to each exam. Exams are identified by patient name and/or by date and time of scan.
MSO	Multiple socket outlet.
Patient	A single person, with unique details such as name, gender, date of birth and EMR Id (electronic medical record).

A

about

User ManualSee User Manual

acoustic output 87

ALARA principle 87

alcohol 12

applicationsSee intended uses

audio feedback 39

B

battery

recharge 69

replacement 59

biological safetySee safety

C

calipersSee also **Measurement**

cavitation 87

classifications 8

clinical troubleshooting 65

connecting cable 76

contact information 19, 66

contraindicationsSee safety

Customer Support 66

D

depths of 4 and 5 CMs 48

dimensions 75

Display specifications 2

disposal 81

distancesee **Measurement**

E

exams 94

external materials 81

I

Image Annotations

voice 52

Intended uses 3

IPX Rating 78

L

labeling 14

latex 34

M

mains charger 87

maintenance 59

Measurement

accuracy 77

B-mode 44, 48

microphone 52

N

navigateSee touch screen

P

package contents 7

patient environment 9

patients 94

Power

button 24, 50

sources 68

R

recommended gel 34

recording 52

references 93

S

safety 81

biological 87

contraindications 3, 13

serviceSee maintenance

setup 24

shutdown 50

solvents 12

sterile sheaths 34

support 66

T

touch screen

navigating 24

trademarks 20

training 7

turn off 50

turn on 24

U

ultrasound

gel 34

risks 87

User Manual 1

conventions 1

version 1, 2

V

version

User ManualSee User Manual

W

warnings 10

Z

Zooming 44, 47