

Kosmos

# AI Station 2 User Guide

---



## Table of Contents

Introduction	3
Kosmos AIS	4
<i>AIS Core Installation</i>	4
<i>Using the utility bin</i>	5
<i>Locking the casters</i>	6
<i>Storing the AC power cord</i>	6
AIS: Kosmos Bridge Installation	7
<i>Installing Kosmos Bridge Tablet Mount to AIS</i>	8
<i>Installing Kosmos Bridge in Bridge Tablet Mount</i>	9
<i>Removing Kosmos Bridge from the Bridge Tablet Mount</i>	10
<i>Locking the release button (optional)</i>	11
<i>Adjusting the tablet mount hinge</i>	11
AIS: Kosmos Bridge with Kosmos Hub	14
<i>Installing Kosmos Hub to AIS</i>	14
AIS: Kosmos on Android	20
AIS: Kosmos on Android without Power Pack	20
<i>Installing Android Tablet to AIS</i>	21
AIS: Kosmos on Android with Power Pack	23
<i>Installing Android Tablet with the Power Pack to AIS</i>	24
<i>Charging the Power Pack</i>	27
AIS: Kosmos on iOS	29
AIS: Kosmos on iOS without Hub	30
<i>Installing iOS Tablet to AIS</i>	31
AIS: Kosmos on iOS with Kosmos Hub	33
Cleaning and disinfecting	39
<i>Routine Maintenance</i>	39
<i>Cleaning the Mounting Assembly</i>	39
Specifications	40
<i>Stand</i>	40
<i>Kosmos Hub</i>	40
<i>Hub Enclosure Box</i>	40
<i>Power Supply</i>	40
<i>Hub to tablet cable length</i>	40
Safety	41
<i>Recycling and Disposal</i>	41
<i>Labeling symbols</i>	43
<i>Contact information</i>	47

\* Android is a trademark of Google LLC.



\* Apple licenses the "iOS" trademark from Cisco.

© 2015 to 2023 EchoNous, Inc., or its affiliates. All rights reserved.

## Introduction

EchoNous offers hardware accessories which allow for longer scanning sessions, simultaneous charge-while-scanning, and collective portability for Kosmos tablets and all Kosmos probes.

The EchoNous AI Station 2 (AIS) is a stand that lets you easily mount and remove the Kosmos Bridge, Android tablet or iOS tablet for convenient use and portability. Additionally, the Kosmos Hub allows Kosmos Bridge users and Kosmos on iOS users to simultaneously scan and charge when Lexsa is connected, when Torso or Torso-One are connected or when both Torso/Torso-One and Lexsa are connected.

	For EU only: Any serious incident that has occurred in relation to the device should be reported to the manufacturer and the competent authority of the Member State in which the user and/or patient is established.
	Torso is only available for Kosmos Bridge.
	Not all features are available in all markets. Reference the user guide of your region or country for all available features before use.



The AIS core assembly instructions remain consistent across all Kosmos platforms. After setting up the AIS, please refer to the appropriate device-specific instructions.

Use this guide in conjunction with the following documents:

- AI Station 2 Installation Guide, Core Stand included in the AIS box
- Kosmos User Guide (if applicable)
- Kosmos on iOS-Android User Guide (if applicable)
- Power Pack Quick Guide (if applicable)

---

---

	Please visit the website at <a href="https://echonous.com/kosmos-resources">echonous.com/kosmos-resources</a> for electronic versions of the user guides.
	Please visit the website at <a href="https://echonous.com/product/device-compatibility">echonous.com/product/device-compatibility</a> for a current list of compatible Android and iOS tablets.

## Kosmos AIS

### AIS Core Installation

	Please note that AIS installation may require two people.
-----------------------------------------------------------------------------------	-----------------------------------------------------------

#### What's in the box

- AIS- Column
- AIS- Base
- Utility Bin
- (2) Cable Clip
- (4) 1/4-20 Lock Nut
- (4) 1/4" Flat Washer



#### To assemble AIS:

1. Lay the base and the column of the AIS on their side.
2. Align the screws on the bottom of the column to match the openings on the base. Connect the base and the column.
3. Tighten the base and the column together using the provided (4) Lock Nuts and (4) Flat Washers.

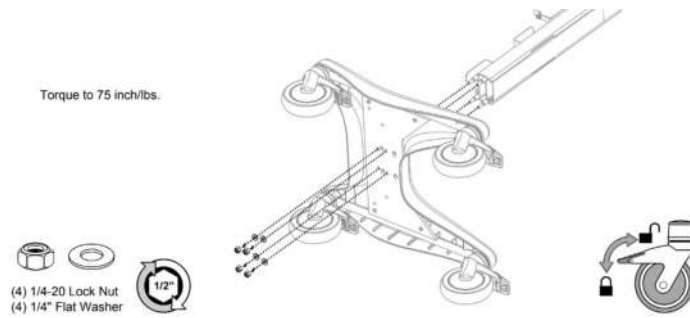

4. Once the column and the base are securely connected, turn the stand upright and slide the Utility bin into place.

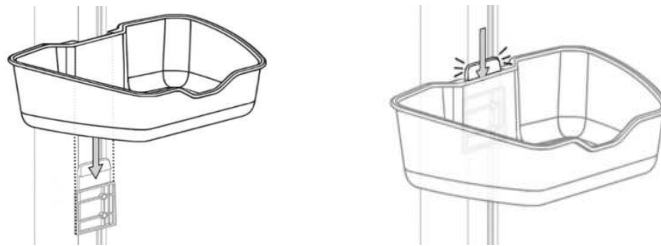

### Using the utility bin

The utility bin can safely carry 4.5 kg.



Do not exceed the safe working load of the AIS.

- 
- 
- ★ To remove the utility bin for cleaning, press the tab, and slide the bin upward.

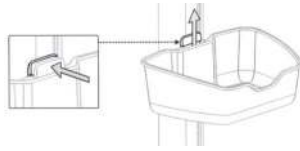

- ★ To reinstall the bin, align it with the top edge of the mounting bracket, and slide the bin downward until it clicks into place.

## Locking the casters

The AIS has four locking casters.



The AIS is designed to roll freely; however, after you have placed it where you want, lock the casters so it does not unintentionally move.

- ★ To lock a caster, use your foot to push down on the tab.

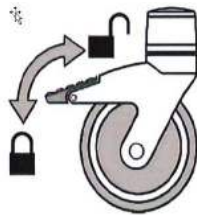

## Storing the AC power cord

- ★ To store the AC power cord, wrap the cord onto the cord wrap at the bottom of the stand.

## AIS: Kosmos Bridge Installation



---

## Installing Kosmos Bridge Tablet Mount to AIS

### What's in the box

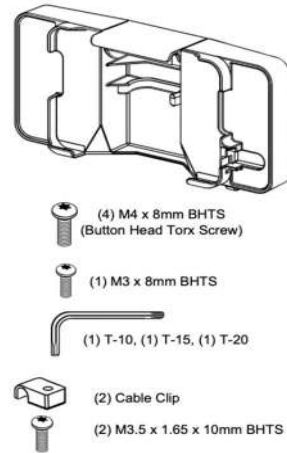

### To install Bridge tablet mount to AIS:

- Using the T-20 Torx wrench, secure the Bridge tablet mount to the AIS column using (4) M4 x 8mm Button Head Torx Screws (BHTS).

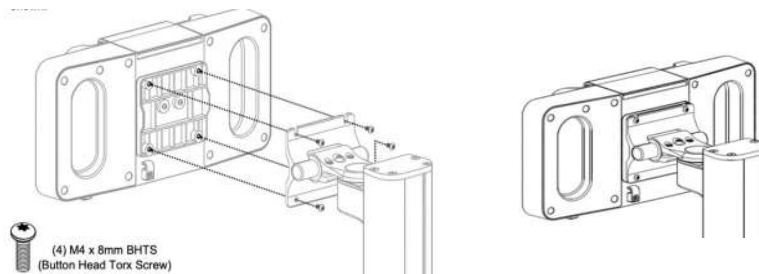



## Installing Kosmos Bridge in Bridge Tablet Mount



Ensure the latch is fully closed so Kosmos Bridge does not fall out and cause injury or damage.

### To install Kosmos Bridge in tablet mount:

1. Align Bridge so that the bottom edge rests on the corner tabs of the tablet mount.

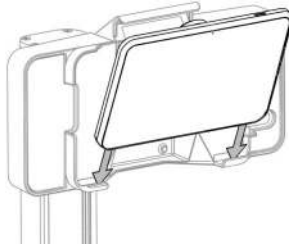

2. Tilt Bridge back into the tablet mount, and press it in. There may be minor resistance as you press the handle into the slot.

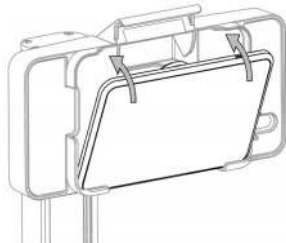



3. Press down on the latch until it clicks.



---

## Removing Kosmos Bridge from the Bridge Tablet Mount

The release button is intentionally hidden to improve security.

	When removing Bridge from the mount, adjust the holder so it is not tilted downward before you push the release so it does not fall to the ground.
	<ul style="list-style-type: none"><li>• The release button simultaneously releases both the latch and the USB cable.</li><li>• Press the release button quickly and completely – this ensures the USB cable properly releases.</li></ul>

### To remove Bridge from the tablet mount:

1. Make sure that Bridge is facing straight forward and not tilted downward.
2. Support Bridge with one hand, and use your other hand to press the release button quickly and completely on the back upper right slot of the tablet mount.



3. Holding the top of the Bridge, tilt it forward and lift up to remove it from the mount.

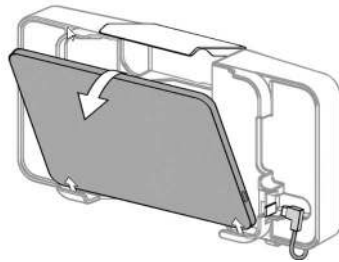

### Locking the release button (optional)

If you want to keep the Bridge in the AIS, you can lock the release button on the top of the tablet mount to ensure the latch does not open.

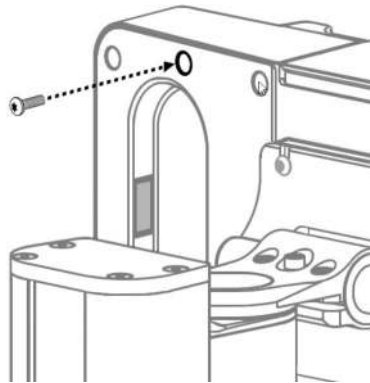

#### To lock the release button:

1. After installing the Bridge in the mount, use the T-10 Torx wrench to install the M3 x 8mm BHTS into the back of the tablet mount. This will lock the release button.



### Adjusting the tablet mount hinge

You can adjust the tablet mount so it tilts up and down (+30/-15 degrees) and swivels left and right (+/- 90 degrees).

	The tilt and swivel tension should only be adjusted after the monitor is installed.
	The downward tilt is intentionally limited to reduce the likelihood that Kosmos Bridge will fall if the latch is accidentally opened.

---

---

### To adjust swivel tension:

1. Using a 1/2" socket wrench, tighten or loosen the swivel tension nut until desired swivel tension is achieved. Socket wrench is not provided.

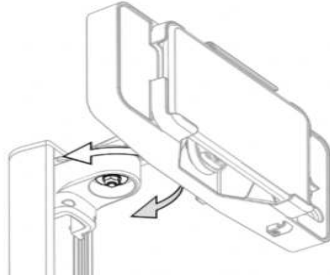

### To adjust tilt tension:

1. Using a 5/32" Allen wrench, tighten or loosen the tension adjustment screws. Allen wrench is not provided.

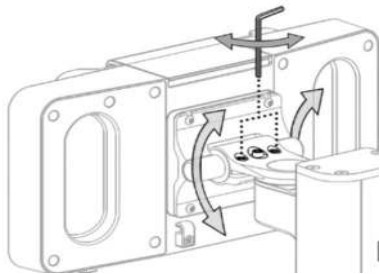

Be sure to support the tablet while adjusting the tension; if the tension is too loose, the tablet mount could suddenly tilt down.

### To begin scanning:

1. Connect Torso/Torso-One into probe port underneath Bridge handle.
2. Connect Lexsa to the USB-C port on the side of the Bridge.

---

**To charge Bridge (without the Hub):**





1. Using the power supply cables provided with your Bridge, connect the USB-C power supply cable end to USB-C port on the side of the Bridge and the other end to the wall outlet. Lexsa must be disconnected from Bridge.

Please continue to the next section for Kosmos Hub installation instructions.

---

## AIS: Kosmos Bridge with Kosmos Hub

### Installing Kosmos Hub to AIS

	While scanning with Lexsa, do not disconnect the AC power if it is already connected.
	Lexsa must be plugged into the Hub Enclosure Box before connecting the Bridge to the Hub. The Bridge will not recognize the Lexsa probe if this sequence is not followed.
	Kosmos Hub must be connected and attached to Kosmos AI Station prior to use.
	The Hub Enclosure Box should not be open while in the patient environment.
	The Kosmos Hub is currently available for Kosmos Bridge and Kosmos on iOS.

#### What's in the Box

- Kosmos Hub
- Hub Enclosure Box
- Hub-to-Bridge USB-C cable
- Hub Power Supply
- (3) M4 x 12mm PHMS
- (1) 1/4-20 x 3/4 Set Screw
- (1) 1/8" Hex wrench

#### To Attach the Hub Enclosure Box to the AIS:

1. At the base of the AIS, insert the mount of the Hub enclosure box, without the Hub, through the opening.

2. Slide the Hub enclosure box up the spine of the stand.

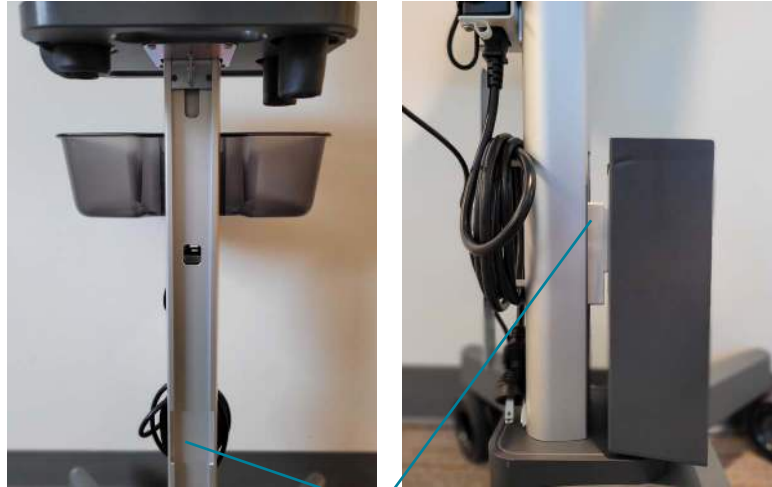

1. Opening for Hub enclosure box mount

3. At the location shown in the image below, use the provided 1/8" Hex wrench and the single Set Screw to tighten the Hub enclosure box to the AIS.

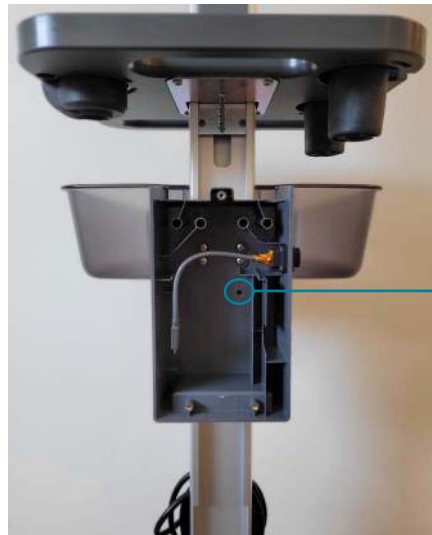

3. Insert Set Screw and tighten with 1/8" Hex wrench until the Hub enclosure box is secure

## Connecting the Hub - See image below

4. Prior to placing the Hub into the Hub enclosure box, connect one end of the Bridge-to-Hub USB-C cable to the USB-C port on the Hub.
5. Place the Hub into the Hub enclosure box. Guide the Bridge-to-Hub USB-C cable through the fittings and cable opening of the Hub enclosure box.
6. Connect the Hub power supply cable to the Hub power supply port.
7. Guide the Hub power supply cable through the fittings and cable opening of the Hub enclosure box.
  - Hint: Utilize the space behind the Hub to help adjust the cable through the fittings.
8. Connect the extension cable (USB-C) to the USB-C ports on the Hub.
9. To scan with Kosmos Lexsa, connect Lexsa to the exterior port on the side of the Hub enclosure box.

 When scanning with Torso/Torso-One, connect the Torso/Torso-one to the Kosmos Bridge (port under the Bridge handle).

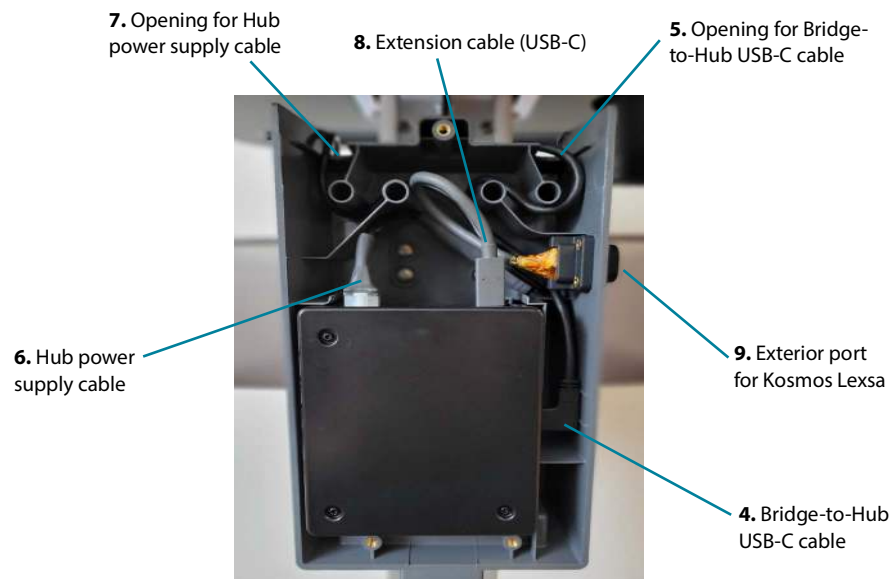



### Connecting the Hub to the Bridge

10. Guide the loose end of the Bridge-to-Hub USB-C cable through the core of the AIS and up to the Bridge mount.

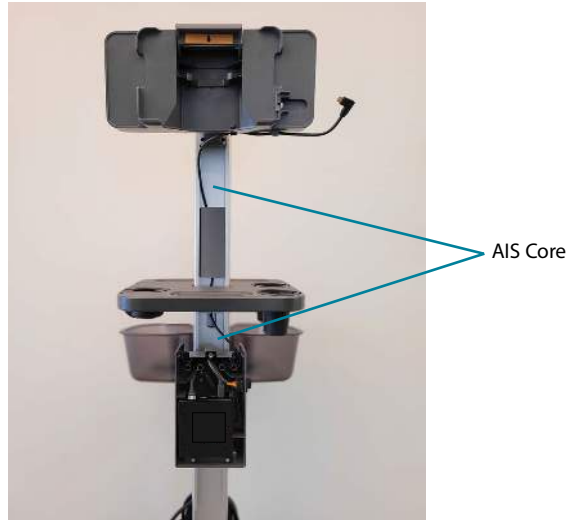

11. Insert the Bridge into the Bridge mount and plug the Bridge-to-Hub USB-C cable into the Bridge side port.



 Lexsa must be plugged into the Hub enclosure box before connecting the Bridge to the Hub.

- 
12. Attach the cable clips to the Bridge tablet mount. Feed the Bridge-to-Hub USB-C cable through the cable clips and tighten the cable clips to the mount using the (2) M3.5 x 1.65 x 10mm BHTS and T-15 Torx wrench.

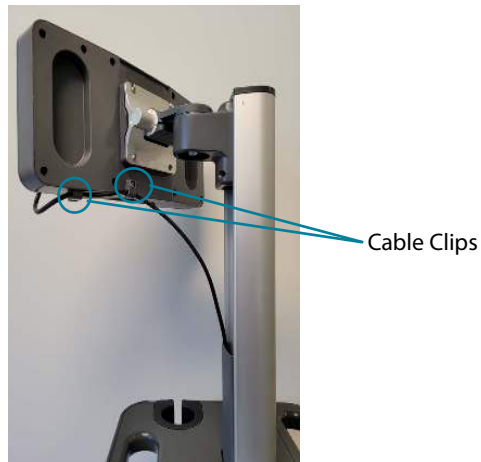

### Complete the Hub Set Up

13. Connect the AC power cable to the Hub power supply.

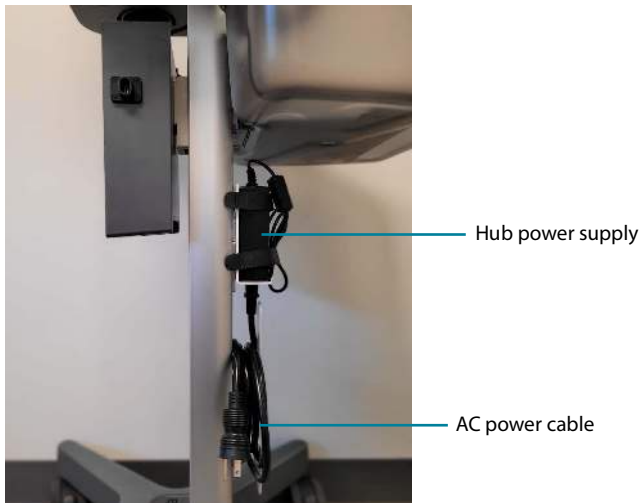



- 
14. Plug the AC power cable into wall outlet. Turn on Kosmos device.
  15. With successful installation of Hub, close the Hub enclosure box with the provided screws. Phillips screwdriver is not provided.

---

## AIS: Kosmos on Android

You can easily mount compatible Android tablets to the AIS using the Android-iOS tablet mount. Android tablet users can also mount the Power Pack to the AIS.

	Electronic user guides are available on the EchoNous website at <b><a href="https://echonous.com/kosmos-resources">echonous.com/kosmos-resources</a></b>
	For a list of compatible tablets, please visit the EchoNous website at <b><a href="https://echonous.com/product/device-compatibility">echonous.com/product/device-compatibility</a></b>
	The Power Pack is only available for Kosmos on Android.

## AIS: Kosmos on Android without Power Pack



## Installing Android Tablet to AIS

### What's in the box

- Android-iOS Tablet Mount
- Button Head Torx Screws (4)
- T-25 Hex wrench
- Washers (4)
- Tablet mount keys (2)
- Tablet mount Allen key
- Penta Nuts (4)
- Penta Nut Key



### To install Android-iOS Tablet Mount to AIS:

1. Align the tablet mount to the AIS mounting plate. Once aligned, insert Button Head Torx screw/washer combo through openings on the mounting plates and secure the ends with Penta Nuts. Use the Hex wrench and Penta Nut Key to tighten hardware.

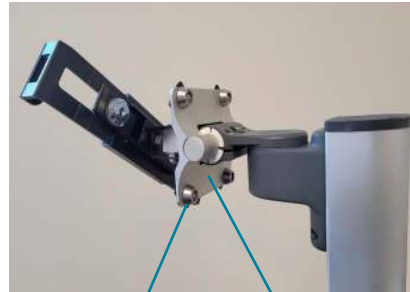
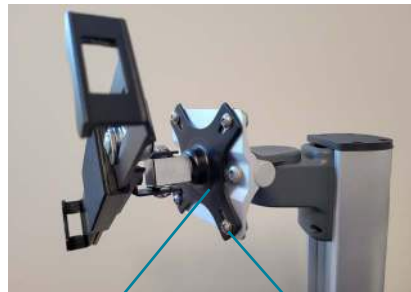

Android-iOS tablet mount plate      Button Head Torx screw/washer      AIS mounting plate  
Penta Nut

---

**To install Android tablet into Android-iOS tablet mount:**

2. To extend the arm of the tablet mount, use the tablet mount key to unlock security latch. Pull back latch and slide/extend arm of the mount.

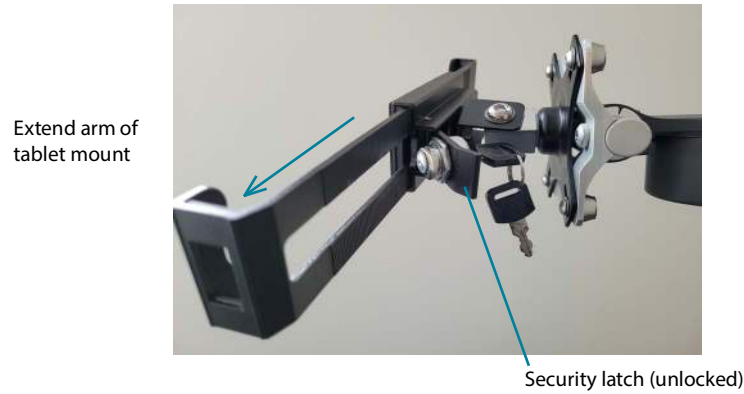

3. Insert tablet corner against fixed end of the mount and secure the adjustable corner to the tablet. Close and lock security latch to hold tablet in place.

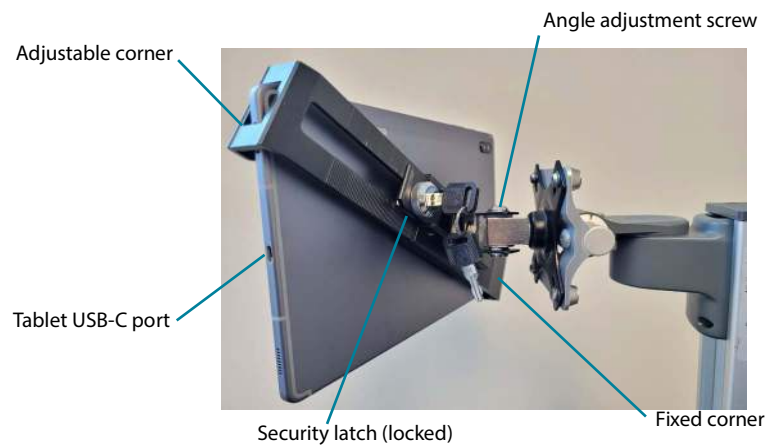

4. Adjust angle of the tablet by tightening or loosening the angle adjustment screw. Use the provided tablet mount Allen key.
5. Connect Kosmos probe to the tablet's USB-C port.

## AIS: Kosmos on Android with Power Pack

📖	Make sure Power Pack is charged prior to use
📖	The Power Pack is only available for Kosmos on Android.
⚠️	Power Pack must be connected to the tablet first in order for the probe to be recognized by the Power Pack.



---

## Installing Android Tablet with the Power Pack to AIS

### What's in the box

- Android-iOS Tablet Mount
- Button Head Torx Screws (4)
- T-25 Hex wrench
- Washers (4)
- Tablet mount keys (2)
- Tablet mount Allen key
- Penta Nuts (4)
- Penta Nut Key
- Power Pack Mount
- Power Pack
- Power Pack power cable
- Charger holster

### Installing Android-iOS Tablet Mount and Power Pack Mount to AIS

1. Referencing the image below, use the Button Head Torx screw/washer/Penta Nut combo to attach the tablet mount and Power Pack mount to the AIS mounting plate. Use the Hex wrench and Penta Nut Key to tighten hardware.

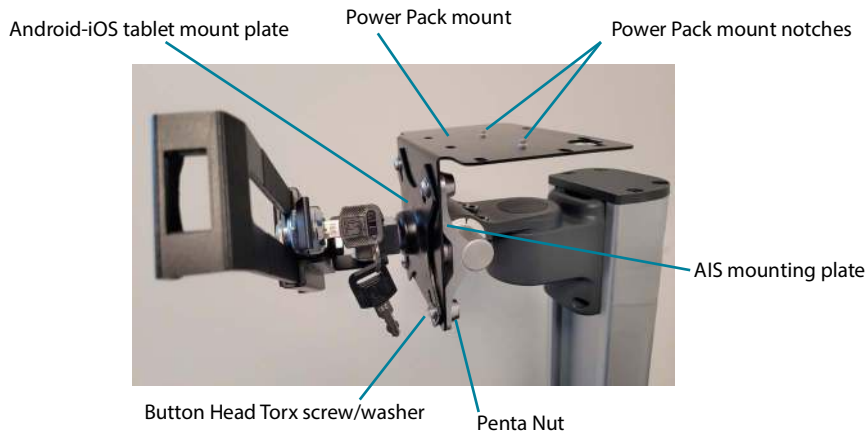



### Securing Power Pack on Power Pack Mount

2. Referencing the images below, place the Power Pack on the Power Pack mount making sure to align the notches on the mount with the openings on the Power Pack. To lock the Power Pack into place slide the Power Pack and push the tab up.



Notch openings

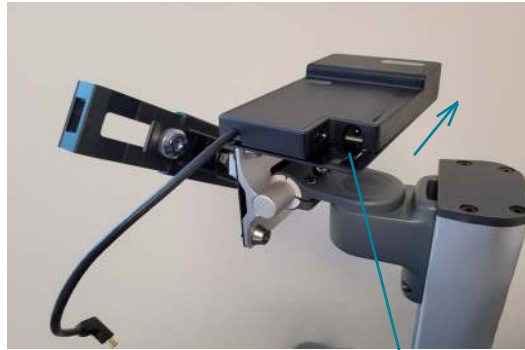

Slide Power Pack to secure

Push tab up to secure Power Pack

### Securing Android tablet in Android-iOS tablet mount

3. To extend the arm of the tablet mount, use the tablet mount key to unlock security latch. Pull back latch and slide to extend arm of the mount.

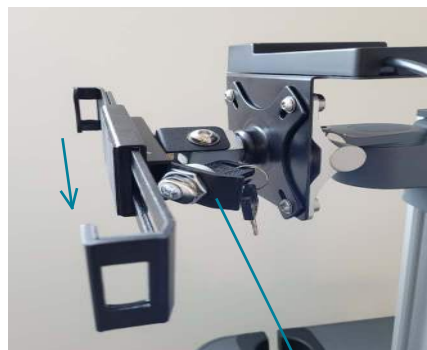

Extend arm of tablet mount

Security latch (unlocked)

4. Insert tablet corner against fixed end of the mount and secure the adjustable mount corner on the tablet. Close and lock security latch to hold tablet in place.

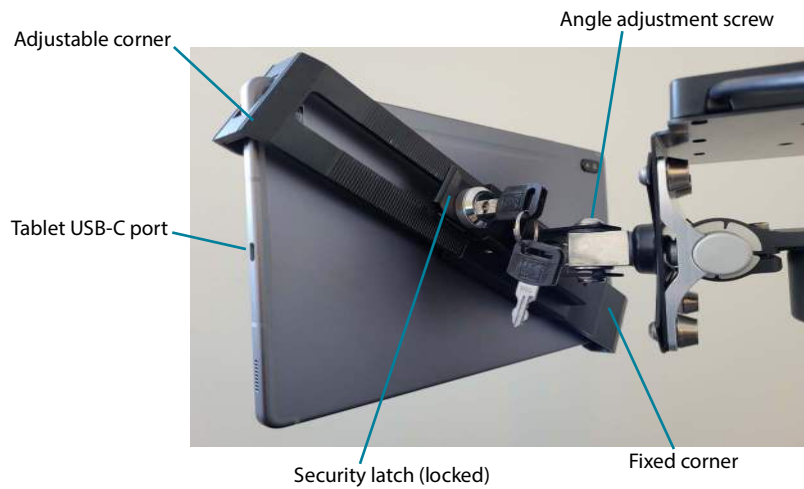

5. First, connect the Power Pack cable to the tablet USB-C port. Followed by connecting the Kosmos probe to the Power pack.

 The Power Pack must be connected to the tablet first in order for the probe to be recognized by the Power Pack.



6. Power on device, open Kosmos App and begin scanning.

### Charging the Power Pack

Use the charger holster to store the Power Pack power supply cable when not in use.

To attach the charger holster to the AIS:

1. Use the strap to secure the charger holster on the power supply mount. See image below.

To charge the Power Pack:

1. Disconnect Kosmos probe from the Power Pack.
2. Guide the power supply cable from the back of the AIS through the core. Pull the cable through to the front.

Back view

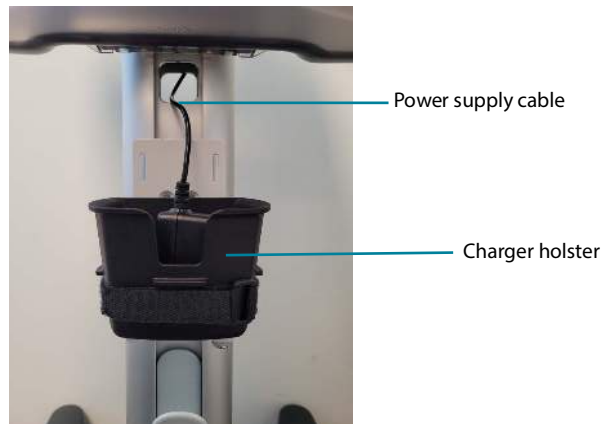

- 
- 
3. Pull the power supply cable up the AIS core towards the Power Pack

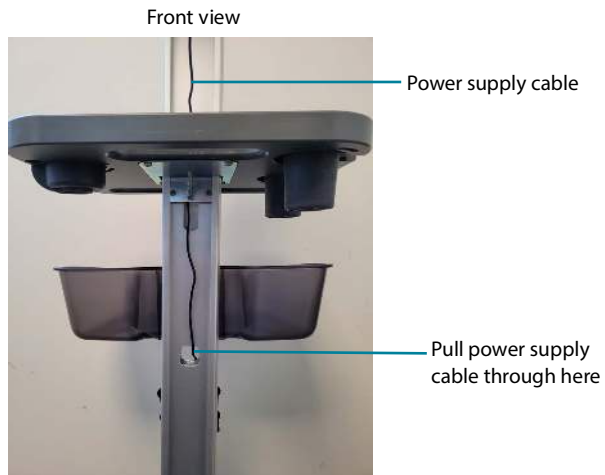

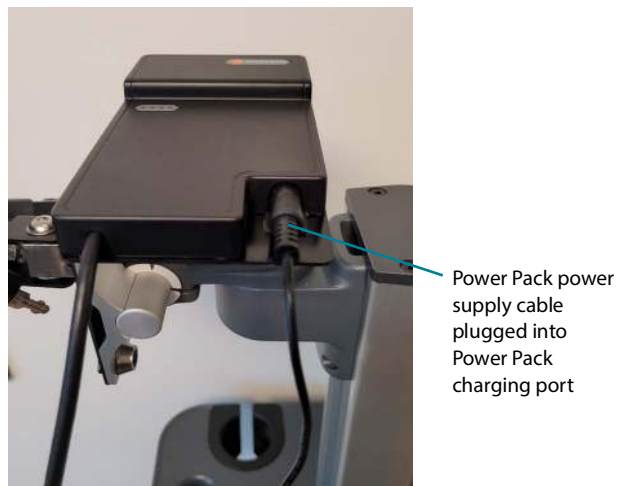

4. Connect the power supply to the Power Pack charging port. To charge both tablet and Power Pack, connect the Power Pack USB-C cable to the tablet.



## AIS: Kosmos on iOS

You can easily mount compatible iOS tablets to the AIS using the Android- iOS Tablet Mount. Kosmos on iOS users can simultaneously scan and charge when using the Kosmos Hub.

	Please note that electronic user guides are available on the EchoNous website at <b><a href="https://echonous.com/kosmos-resources">echonous.com/kosmos-resources</a></b>
	For a list of compatible tablets, please visit the EchoNous website at <b><a href="https://echonous.com/product/device-compatibility">echonous.com/product/device-compatibility</a></b>
	Please note that the Kosmos Hub is only available for Kosmos Bridge and Kosmos on iOS.

---

---

AIS: Kosmos on iOS without Hub



## Installing iOS Tablet to AIS

### What's in the box

- Android-iOS Tablet Mount
- Button Head Torx Screws (4)
- T-25 Torx wrench
- Washers (4)
- Tablet mount keys (2)
- Tablet mount Allen key
- Penta Nuts (4)
- Penta Nut Key



### Installing Android-iOS Tablet Mount to AIS

1. Align tablet mount to the AIS mounting plate. Insert Button Head Torx screw/washer combo through openings and secure the ends with Penta Nuts. Use the Torx wrench and Penta Nut Key to tighten hardware.



Android-iOS tablet mount plate      Button Head Torx screw/washer      Penta Nut      AIS mounting plate

---

## Installing iOS tablet into Android-iOS tablet mount

2. To extend the arm of the tablet mount, use the tablet mount key to unlock security latch. Pull back latch and slide/extend arm of the mount.

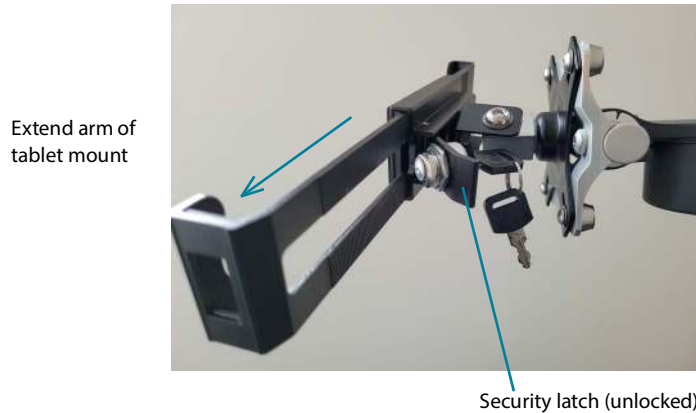

3. Insert tablet corner against fixed end of the mount and secure the adjustable mount corner of the tablet. Close and lock security latch to hold tablet in place.

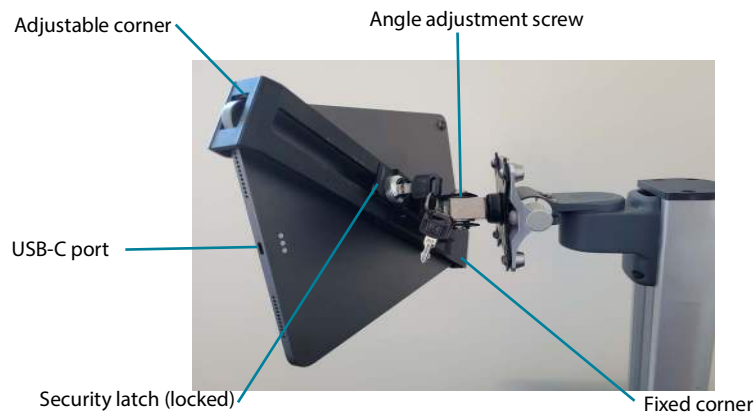

4. Adjust angle of the tablet by tightening or loosening the angle adjustment screw using the tablet mount Allen key.
5. Connect Kosmos Probe to the tablet's USB-C port.









AIS: Kosmos on iOS with Kosmos Hub



---

## Installing Kosmos Hub to AIS

	While scanning, do not disconnect the AC power if it is already connected.
	Kosmos Hub must be connected and attached to Kosmos AI Station prior to use.
	Only use the iOS-to-Hub USB-C cable (P007934) provided by EchoNous to connect your iOS tablet to the Hub. Using a different cable may cause system interruption.
	The Hub Enclosure Box should not be open while in the patient environment.
	The Kosmos Hub is only available for Kosmos Bridge and Kosmos on iOS users.
	Please note that not all features are available in all markets. Reference the user guide of your region or country for all available features before use.

### What's in the Box

- Kosmos Hub
- Hub Enclosure Box
- Hub-to-Bridge USB-C cable
- Hub Power Supply cable
- AC power cable
- (3) M4 x 12mm PHMS
- (1) 1/4-20 x 3/4 Set Screw
- (1) 1/8" Hex wrench

### To attach Hub Enclosure Box to the AIS

1. At the base of the AIS, insert the mount of the Hub enclosure box, without the Hub, through the opening. Slide the Hub enclosure box up the spine of the stand.

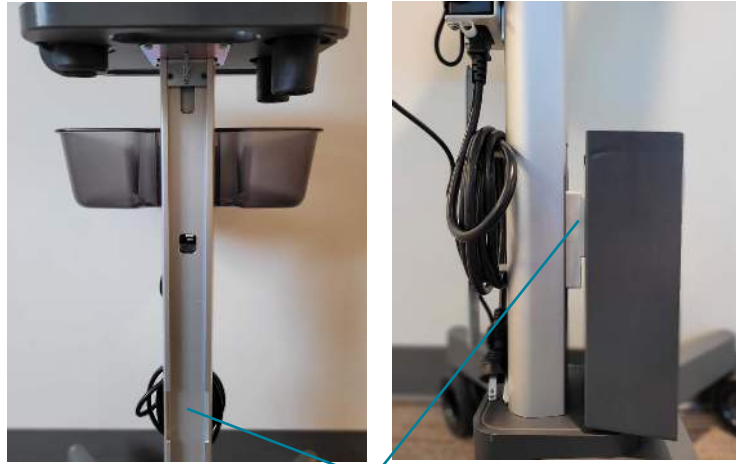

1. Opening for Hub enclosure box mount

2. At the location shown in the image below, use the provided 1/8" Hex wrench and the single Set Screw to tighten the Hub enclosure box to the AIS.

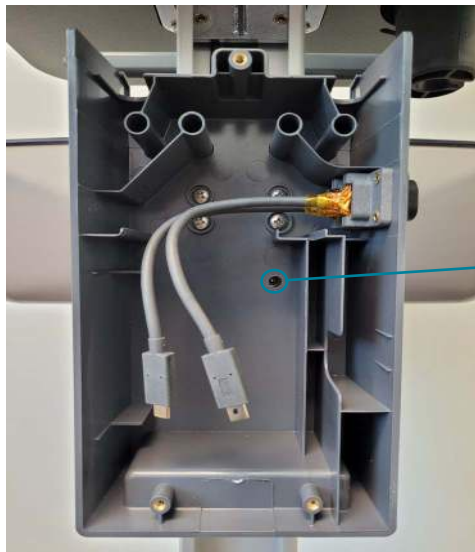

2. Insert Set Screw and tighten with 1/8" Hex wrench until the Hub enclosure box is secure

---

### Connecting the Hub - See image below

3. Prior to placing the Hub into the Hub enclosure box, connect one end of the iOS-to-Hub USB-C cable to the USB-C port on the Hub.
4. Place the Hub into the Hub enclosure box. Guide the iOS-to-Hub USB-C cable through the fittings and cable opening of the Hub enclosure box.
5. Connect the Hub power supply cable to the Hub power supply port.
6. Guide the Hub power supply cable through the fittings and cable opening of the Hub enclosure box.
  - Hint: Utilize the space behind the Hub to help adjust the cable through the fittings.
7. Connect the Extension Cable (USB-C) to the USB-C ports on the Hub.
8. Plug in Kosmos Lexsa and/or Kosmos Torso-One to the exterior ports on the Hub enclosure box.

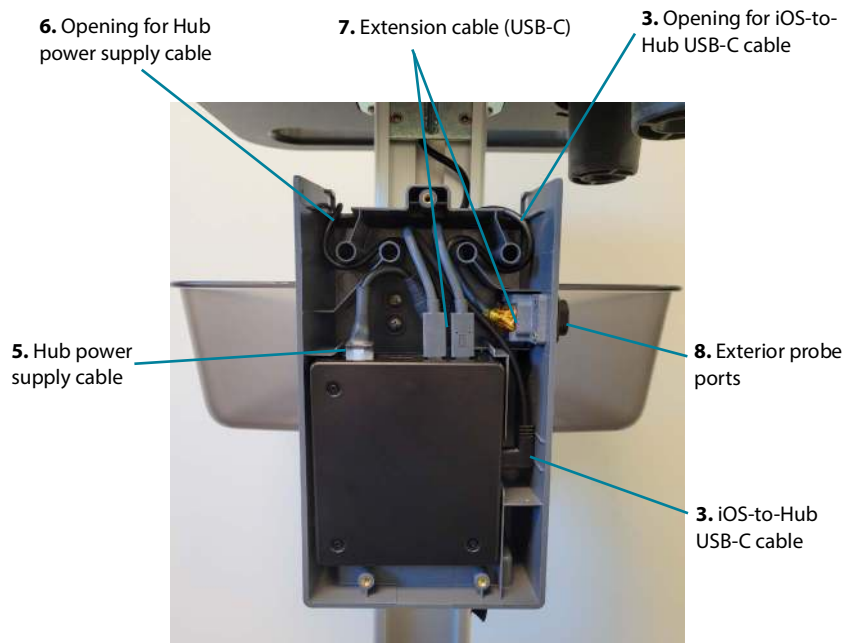

### Connecting the Hub to the iOS Device and Power Supply

9. Guide the loose end of the iOS-to-Hub USB-C cable through the core of the AIS and up to the tablet mount.

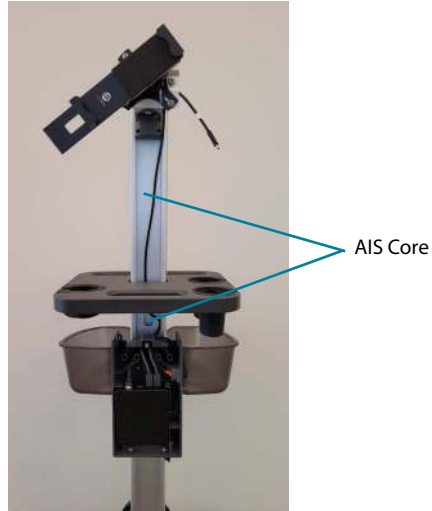

10. Place the iOS device into the tablet mount and plug the iOS-to-Hub USB-C cable into the USB-C port on the side of the iOS device.



---

## Complete the Hub Set Up

11. Connect the AC power cable to the Hub power supply.

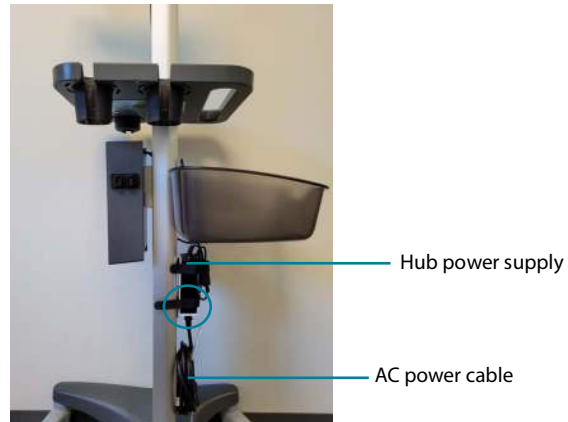

12. Plug the AC power cable into wall outlet. Turn on Kosmos device.
13. With successful installation of the Hub, close the Hub Enclosure Box with the provided screws. Phillips screwdriver is not provided.

## Cleaning and disinfecting

For cleaning and disinfection of the AIS, refer to the manufacturer's instructions. ([https://assets.gcx.com/documents/documents/DU-CLEAN-01\\_Rev\\_A.PDF](https://assets.gcx.com/documents/documents/DU-CLEAN-01_Rev_A.PDF))

### Routine Maintenance

Periodically inspect all fasteners associated with the mounting assembly. Tighten or Adjust as necessary for optimal operation and safety.

### Cleaning the Mounting Assembly

The mounting assembly may be cleaned with most mild, non-abrasive solutions commonly used in the hospital environment (e.g. diluted bleach, ammonia, or alcohol solutions).

The surface finish will be permanently damaged by strong chemicals and solvents such as acetone or trichloroethylene.

Steel wool or other abrasive material should never be used.

Damage caused by the use of unapproved substances or processes will not be warranted. We recommend testing of any cleaning solution on a small area of the mounting assembly that is not visible to verify compatibility.

Never submerge or allow liquids to enter the mounting assembly. Wipe any cleaning agents off the mounting assembly immediately using a water-dampened cloth. Dry the assembly thoroughly after cleaning.



GCX makes no claims regarding the efficacy of the listed chemicals or processes as a means for controlling infection. Consult your hospital's infection control officer or epidemiologist. To clean or sterilize mounted devices or accessory equipment, refer to the specific instructions delivered with those products.

---

## Specifications

### Stand

- Weight: 24.5 kg
- Dimensions: 112 x 51 x 45 cm

### Kosmos Hub

- Dimensions: 100 x 116 x 31 mm

### Hub Enclosure Box

- Dimensions: 132 x 237 x 71 mm

### Power Supply

- Input: 100-240V AC supply 50-60Hz
- Output: 5.0V  $\pm$ 0.25V at 2.0A maximum current

### Hub to tablet cable length

- 1800 mm (70.9")



## Safety

Please read this information before using your ultrasound system. It applies to the device, the transducers, and the software. This section covers general safety information only. Safety information that applies only to a specific task is included in the procedure for that task.

Kosmos System is considered a medical device. This device is intended for use by, or by the order of, and under the supervision of a licensed physician qualified to direct the use of the device.

Report any serious safety incident that occurs in relation to the ultrasound system to EchoNous and to the competent authority of the country in which the user and/or patient are established.

## Recycling and Disposal



EchoNous is committed to helping protect the natural environment not only through supporting continued safe and effective use of the devices, but also through communicating information about proper disposal of the devices at the end of useful life.

Equipment may contain materials that pose a risk to the environment if not disposed of properly. When a device has reached the end of its useful life, properly dispose of it following the recommendations below.



Kosmos Bridge contains lithium-ion batteries, and the system should be disposed of in an environmentally responsible manner in compliance with local, state, provincial, and/or national regulations. EchoNous recommends taking any Kosmos electronic equipment to a recycling center which specializes in the recycling and disposal of electronic equipment. In cases where any Kosmos component has been exposed to biologically hazardous material, EchoNous recommends using biohazard containers in compliance with local, state, provincial, and/or national regulations for disposal. Such Kosmos component



---





should be taken to a waste center which specializes in the disposal of biohazard waste.

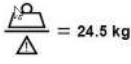



	Do not incinerate or discard Kosmos in general waste at end of life. The lithium-ion battery is a potential environmental and fire safety hazard.
	The lithium-ion battery inside Kosmos Bridge may explode if exposed to very high temperatures. Do not destroy this unit by incinerating or burning. Return the unit to EchoNous or your local representative for disposal.

Labeling symbols

Symbol	EchoNous Description	SDO Title Reference Number Standard
	<p>Indicates device manufacturer. Includes name and address of the manufacturer</p>	<p>Manufacturer Ref. No. 5.1.1 ISO 15223-1 Medical devices - Symbols to be used with medical device labels, labeling and information to be supplied - Part 1: General requirements</p>
<p><b>REF</b></p>	<p>Part or model number</p>	<p>Catalog number Ref. No. 5.1.6 ISO 15223-1 Medical devices - Symbols to be used with medical device labels, labeling and information to be supplied - Part 1: General requirements</p>
	<p>Date of manufacture</p>	<p>Date of manufacture Ref. No. 5.1.3 ISO 15223-1 Medical devices- Symbols to be used with medical device labels, labeling and information to be supplied- Part 1: General requirements</p>

<b>LOT</b>	Batch code	Batch code Ref. No. 5.1.5 ISO 15223-1 Medical devices - Symbols to be used with medical device labels, labeling and information to be supplied - Part 1: General requirements
<b>SN</b>	Serial number	Serial number Ref. No. 5.1.7 ISO 15223-1 Medical devices- Symbols to be used with medical device labels, labeling and information to be supplied- Part 1: General requirements
	Equipment mass including safe working load. Used in accordance with IEC 60601-1, Cl. 7.2.21.	None
	UL Classified. Medical - General medical equipment as to electrical shock, fire and mechanical hazards only in accordance with ANSI/AAMI ES 60601-1 (2005) + AMD (2012) / CAN/CSA-C22.2 No. 6060-1 (2008) + (2014). E509516	None

	<p>Consult instructions for use</p>	<p>Operating instructions                      Ref. No. D.1-11                      IEC 60601-1                      Medical electrical equipment                      - Part 1: General requirements for basic safety and essential performance</p>
	<p>Safety cautions are identified with this mark on the device.</p>	<p>Caution                      Ref. No. D.1-10                      IEC 60601-1                      Medical electrical equipment                      - Part 1: General requirements for basic safety and essential performance</p>
	<p>Indicates the item is a medical device</p>	<p>Ref. No. 5.7.7                      ISO 15223-1                      Medical devices- Symbols to be used with medical device labels, labeling and information to be supplied-                      Part 1: General requirements</p>
	<p>Indicates the authorized representative in the European Community/ European Union</p> <p>Note: Symbol is accompanied by the name and address of the authorized representative.</p>	<p>Ref. No. 5.1.2                      ISO 15223-1                      Medical devices- Symbols to be used with medical device labels, labeling and information to be supplied-                      Part 1: General requirements</p>

	<p>CE Marking</p> <p>Indicates that a device is in conformity with the applicable requirements set out within EU MDR 2017/745 and other applicable Union harmonization legislation</p>	<p>EU MDR 2017/745</p> <p>Article 2, (43)</p>
	<p>Indicates direct current</p>	<p>Direct current</p> <p>Ref. No. D.1-4</p> <p>IEC 60601-1</p> <p>Medical electrical equipment - Part 1: General requirements for basic safety and essential performance</p>
	<p>Do not dispose of this product in normal trash or landfill; refer to local regulations for disposal</p>	<p>Separate collection Annex IX</p> <p>Waste Electrical and Electronic Equipment (WEEE)</p> <p>Directive 2012/19/EU of the European Parliament</p>
	<p>Switzerland representative</p>	<p>Symbol for Switzerland Representative</p> <p>MU600_00_016e_MB</p>
	<p>UK Conformity Assessed</p>	<p>Symbol for UK Conformity Assessed.</p> <p>MHRA Department of Business, Energy &amp; Industrial Strategy December 31, 2020</p>

## Contact information

### United States



EchoNous Inc.

8310 154th Avenue NE

Building B, Suite 200

Redmond, WA 98052

Technical Support (toll free): (844) 854 0800

Sales (toll free): (844) 854 0800

Email: support@EchoNous.com

Website: www.EchoNous.com

### European Economic Area



Authorized Representative

Advena Ltd

Tower Business Centre

2nd Flr, Tower Street

Swatar, BKR 4013

Malta



---

## Switzerland Authorized Representative

CH REP

QUNIQUE GmbH  
Bahnhofweg 17  
5610-Wohlen  
Switzerland

## UK Responsible Person Qserve

Group UK, Ltd  
49 Greek St, London W1D 4EG,  
United Kingdom

## Australia Sponsor

LC & Partners Pty Ltd  
Level 32, 101 Miller Street  
North Sydney, NSW, 2060  
Australia  
Tel: + 61 2 9959 2400

## Brazil Authorized Representative

### Detentor da Notificação:

### VR Medical Importadora e Distribuidora de Produtos Médicos Ltda

Rua Batataes no 391, conjuntos 11, 12 e 13 - Jardim Paulista  
São Paulo - SP - 01423-010  
CNPJ: 04.718.143/0001-94  
SAC: 0800-7703661  
Farm. Resp: Cristiane Ap. de Oliveira Aguirre – CRF/SP: 21.079  
Notificação ANVISA no: 80102519147



**Suporte ao cliente da EchoNous**

**Entre em contato com o suporte ao cliente:**

**Telefone:** 844-854-0800

**Fax:** 425-242-5553

**E-mail:** [info@echonous.com](mailto:info@echonous.com)

**Site:** [www.echonous.com](http://www.echonous.com)

**Fabricante:**

EchoNous, Inc.

8310 154th Ave NE, Edifício B, Suíte 200

Redmond, WA 98052

Estados Unidos da América

**País de Origem:** Estados Unidos da América